

A B A R T H 5 9 5 / 6 9 5



A U S T R A L I A V E R S I O N

This supplement describes the main characteristics of the Fiat  and  Abarth right hand drive version.

To obtain peak engine condition and to ensure maximum performance of all of its components, it is necessary to observe the instructions for vehicle use and vehicle maintenance described in this booklet.

FCA Australia recommends that customers have all maintenance and, where necessary, repairs, carried out at an authorised Abarth repairer. Please see website [www.fiat.com.au/fiat-dealers](http://www.fiat.com.au/fiat-dealers) for a list of authorised Abarth repairers in your region (\*).

Authorised Abarth repairers use highly qualified technical staff and ensure that only appropriate equipment and tools are used on your vehicle.

Failure to carry out maintenance at the recommended intervals can result in deterioration of your vehicle.

Components have been fitted in accordance with the relevant Australian Design Rules for your vehicle.

This supplement contains information regarding the correct use and care of these vehicle components.

For any topic not specifically dealt with in this supplement, refer to the main Owner's Handbook which should be read thoroughly to ensure that the vehicle is used correctly and safely.

(\* ) Not all authorised Abarth dealers will also be authorised Abarth repairers. Please contact your dealer for more information.

# DASHBOARD

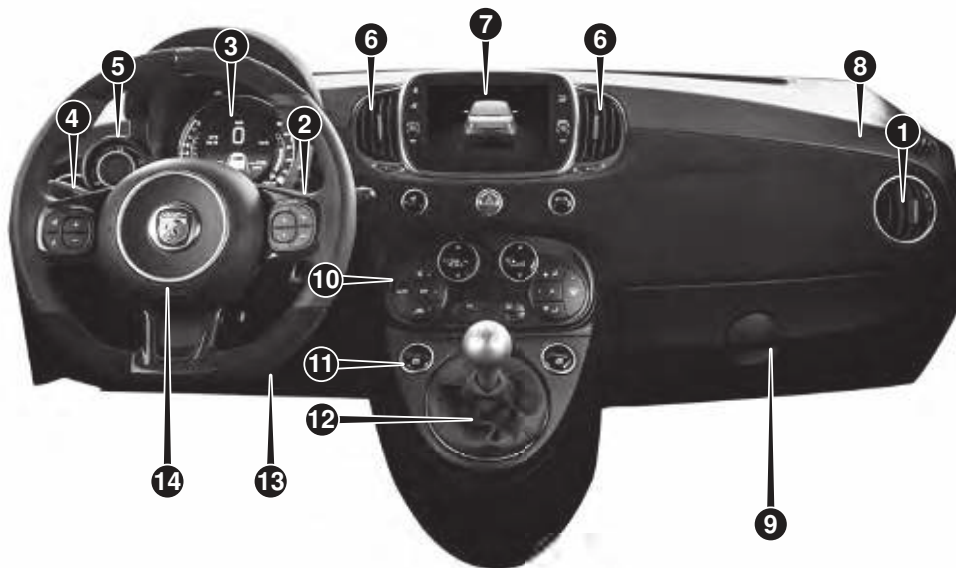

1

AB0A0468

1. Side vent – 2. Right stalk: controls wiper, washer, trip computer – 3. Instrument panel and warning lights – 4. Left stalk: external lights controls – 5. Turbo pressure gauge – 6. Central air vents – 7. **Uconnect™** – 8. Passenger air bag – 9. Oddment compartment/document tray – 10. Heating/ventilation/climate control – 11. Power windows control – 12. Gear lever – 13. Driver knee bag – 14. Driver air bag.

AUSTRALIA VERSION

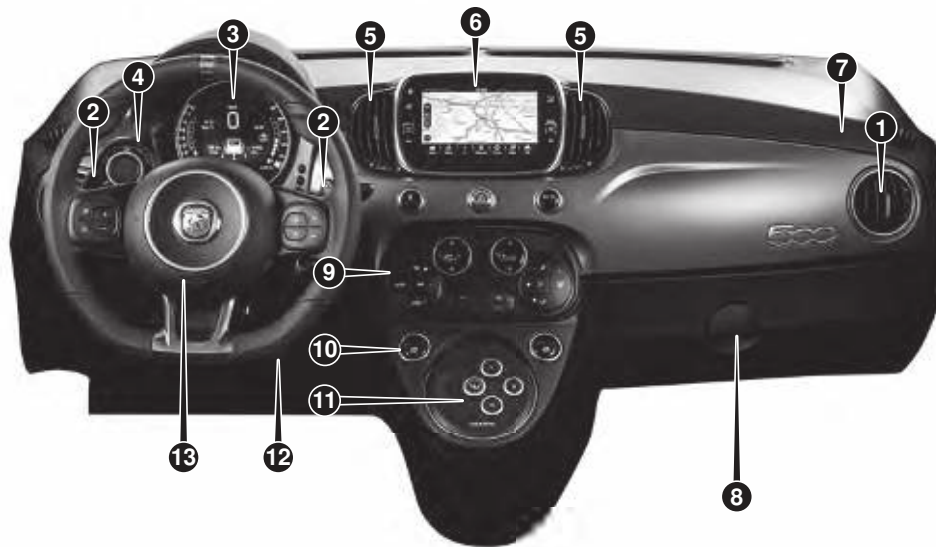

2

AB0A0469

1. Side vent – 2. Levers on steering wheel (only versions with Abarth competizione transmission) – 3. Instrument panel and warning lights – 4. Turbo pressure gauge – 5. Central air vents – 6. Oddment/Car radio compartment – 7. Passenger air bag – 8. Oddment compartment/document tray – 9. Heating/ventilation/climate control – 10. Power windows control – 11. Abarth competizione transmission – 12. Driver knee bag – 13. Driver air bag.



## CHILD RESTRAINTS



The recommendation of the ISO child (restraints) seats to be used with the vehicle in the main Owner Handbook complies with AS/NZS 1754-2013.

### CHILD RESTRAINT INSTALLATION

Your vehicle has been designed to accommodate child restraints on the rearmost seats. When using a child restraint, read the Installation Instructions supplied with the child restraint and follow the directions for fitment carefully.

Fasten the upper belt (that is supplied together with the child seat) to the fastener B-fig. 3 set between the rear back-rest and the boot floor.



3

FOS0134

### INSTALLATION OF THE ATTACHING CLIP

Correct engagement of the child restraint attaching clip 1-fig. 4 is achieved by depressing the retainer spring 2 and then passing through the opening of the anchor fitting 3 as shown in the illustration.

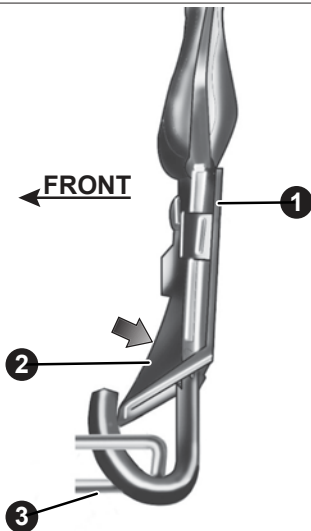

4

FOS167Ab



### WARNING

1) When installing a child restraint ensure that head restraint is raised and tether strap is placed underneath directly on the top of the seat back. Child restraint anchorages are designed to withstand only those loads imposed by correctly fitted child restraints. Under no circumstances are they to be used for adult seat belts, harnesses or for attaching other items or equipment to the vehicle.

## Child restraint system installation

The table provides guidelines on positioning child restraint systems on the car seats. Each child restraint system position complies with the UNECE standards



Seat number	Number of seats							
	1	2	3		4	5*	6	
			Airbag ENABLED	Airbag DISABLED				
Seat suitable for rearward facing child restraint systems (U)	X	X	NO	NO	YES	X	YES	
Seat suitable for forward facing child restraint systems (UF)	X	X	NO	NO	YES	X	YES	
i-Size seat (i-U)	X	X	NO	NO	NO	X	NO (1)	
Seat suitable for ISOFIX side fixtures (L1 / L2)	X	X	NO	NO	NO	X	NO	
Seat suitable for ISOFIX rearward facing fixtures (R1/ R2 / R3) (IL)	X	X	NO	NO	NO	X	YES (R1 and R2 only) **	

Seat number	Number of seats						
	1	2	3		4	5*	6
			Airbag ENABLED	Airbag DISABLED			
Seat suitable for ISOFIX forward facing fixtures (F2/ F2X / F3) (IUF)	X	X	NO	NO	YES	X	YES
Seat suitable for forward facing Booster fixtures (B2/ B3 fixtures)	X	X	NO	NO	NO (1)	X	Only B2

U = Position suitable for a "universal" child restraint system approved for this weight category.

UF = Position suitable for a "universal" forward facing child restraint system approved for this weight category.

IUF = Position suitable for an "ISOFIX" universal forward facing child restraint system approved for this weight category.

i-U = Position suitable for an i-Size "universal" forward facing or rearward facing child restraint system.

i-UF = Position suitable for an i-Size "universal" forward facing child restraint system.

IL = Position suitable for specific listed ISOFIX child restraint systems (CRS). These ISOFIX CRS are classified as "car-specific", "restricted use" and "semi-universal".

X = Not applicable. The seat is not approved for installation of child restraint systems.

\*\* = Installation only possible by moving the corresponding front seat forward. In this configuration, the seat must not be occupied.

(1) = This seat is not approved for use with this category of child restraint systems. Nevertheless, it may still be possible to install this category of child restraint system. Therefore, check the compatibility of this vehicle with the identified child restraint system on the manufacturer's website.

NOTE For any further details on installation/use, refer to the instruction manual for the child restraint system.

## SUPPLEMENTARY RESTRAINT SYSTEM (SRS) - AIRBAG



### FRONT AIRBAGS

#### Passenger side front airbag

On this vehicle model it is not possible to disable the passenger front Airbag.

#### Passenger side front airbag and child restraint systems

The vehicle is equipped with a Supplementary Restraint System airbag for the front passenger. Under no circumstances attempt to install a child seat or child restraint device on the front passengers seat.



#### WARNING

**2) NEVER use a rearward facing child restraint on a seat protected by an ACTIVE AIRBAG in front of it, DEATH or SERIOUS INJURY to the CHILD can occur.**



5

AB0A0308

## FUEL TYPE

The engine in this vehicle is designed to use only unleaded fuel with an octane rating (RON) not less than 95. For the type of fuel to use and for information regarding what to do if your car is accidentally filled with other types of fuel see the main owner's manual. Use unleaded fuel only.



# NOTE

AUSTRALIA VERSION

A series of horizontal dotted lines for writing notes, spanning the width of the page.

Handwriting practice area with 20 horizontal dotted lines.

FCA Italy S.p.A. – MOPAR – Technical Service Operations - Service Library  
Largo Senatore G. Agnelli 3 – 10040 Volera – Torino (Italy)  
Print N. 603.53.929 – 04/2021 – 1 Edition

A B A R T H 5 9 5 / 6 9 5



O W N E R H A N D B O O K

**Dear Customer,**

We would like to congratulate and thank you for choosing an Abarth 595/695. We have written this handbook to help you get to know all the features of your car and use it in the best possible way. You should read it right through before taking to the road for the first time.

Here you will find information, advice and important warnings about using the car and how to achieve the best performance from the technological features of your Abarth 595/695. It also provides a description of special features and essential information for the care and maintenance of your car over time as well as for safe driving.

In the attached Warranty Booklet you will also find a description of the Services that Abarth offers to its customers, the Warranty Certificate and the detail of the terms and conditions for maintaining its validity.

We are confident that these will bring you closer to your new car and make you appreciate the assistance provided by the Abarth team.

Enjoy reading. Happy driving!

**This Owner Handbook describes all versions of the Abarth 595/695; please consider only the information relevant to the trim level, engine and version of your car. All data contained in this publication are purely indicative. FCA Italy S.p.A. can modify the specifications of the vehicle model described in this publication at any time, for technical or marketing purposes. For further information, contact an Abarth Dealership.**

# READ THIS CAREFULLY

## REFUELLING



Only refuel with unleaded petrol with octane rating (RON) not less than 95, in compliance with the European specification EN 228. The use of other products or mixtures may damage the engine beyond repair and consequently invalidate the warranty, due to the damage caused.

## STARTING THE ENGINE



**Version with manual transmission:** make sure that the handbrake is engaged; set the gear lever to neutral; fully depress the clutch pedal without pressing the accelerator, then turn the ignition key to AVV and release it as soon as the engine has started.

**Versions with robotised sequential transmission:** make sure that the handbrake is engaged and that the gear lever is in P (Parking) or N (Neutral), fully depress the brake pedal, then turn the ignition key to AVV and release it as soon as the engine is started.

## PARKING ON FLAMMABLE MATERIAL



The catalytic converter develops high temperatures during operation. Do not park the car on grass, dry leaves, pine needles or other flammable material: fire hazard.

## RESPECTING THE ENVIRONMENT



The vehicle is fitted with a system that carries out a continuous diagnosis of the emission-related components in order to help protect the environment.

## ELECTRICAL ACCESSORIES



If, after buying the car, you decide to install electrical accessories (with the risk of gradually draining the battery), contact an Abarth Dealership. They will calculate the overall electrical consumption and check that the car's electrical system can support the required load.

## CODE Card

(where provided)



Keep it in a safe place, not in the car. We recommend that you always carry the electronic code provided on the CODE Card with you, in case you need to perform an emergency start.

## SCHEDULED SERVICING



Correct maintenance of the car is essential for ensuring that it maintains its performance and its safety features, its environmental friendliness and low running costs for a long time to come.

## THE OWNER HANDBOOK CONTAINS



... important information, advice and warnings for correct use, driving safety and maintenance of your car over time. Special attention must be paid to the symbols provided ⚠️ (safety of persons) 🌱 (environmental protection) 🚗 (car integrity).

## SYMBOLS

Some car components have coloured labels whose symbols indicate precautions to be observed when using this component. Under the bonnet there is also a label that summarises all the symbols.

# CHANGES/ALTERATIONS TO THE CAR

## WARNING

Any change or alteration of the car might seriously affect its safety and road holding, thus causing accidents, in which the occupants could even be fatally injured.

## ACCESSORIES PURCHASED BY THE OWNER

If after buying the car, you decide to install electrical accessories that require a permanent electrical supply (e.g. radio, satellite anti-theft system, etc.) or accessories that in any case burden the electrical supply, contact an Abarth Dealership, whose personnel will check whether the car's electrical system is able to withstand the load required, or whether it needs to be integrated with a more powerful battery.

**IMPORTANT** Take care when fitting additional spoilers, alloy wheel rims or non-standard wheel hubs: they could reduce the ventilation of the brakes and affect efficiency under sharp, repeated braking or on long descents. Make sure that nothing obstructs the pedal stroke (mats, etc.).

## INSTALLING ELECTRICAL/ELECTRONIC DEVICES

Electrical and electronic devices installed after buying the vehicle in the context of after-sales service must carry the following label .

FCA Italy S.p.A. authorises the installation of transceivers provided that installation is carried out at a specialised centre, in a workmanlike fashion and in compliance with manufacturer's specifications.

**IMPORTANT** Traffic police may not allow the car on the road if devices have been installed which modify the features of the car. This may also cause invalidation of warranty in relation to faults caused by the change either directly or indirectly related to it. FCA Italy S.p.A. shall not be liable for damage caused by the installation of accessories either not supplied or recommended by FCA Italy S.p.A. and/or not installed in compliance with the provided instructions.

## RADIO TRANSMITTERS AND MOBILE PHONES

Radio transmitter equipment (car mobile phones, CB radios, amateur radio etc.) cannot be used inside the car unless a separate aerial is mounted on the roof.

**WARNING** The use of these devices inside the passenger compartment (without an external aerial) may cause the electrical systems to malfunction. This could compromise the safety of the car in addition to constituting a potential hazard for passengers' health. In addition, transmission and reception of these devices may be affected by the shielding effect of the car body. As far as the use of EC-approved mobile phones is concerned (GSM, GPRS, UMTS, LTE), follow the usage instructions provided by the mobile phone Manufacturer.

# USE OF THE OWNER HANDBOOK

## OPERATING INSTRUCTIONS

Each time direction instructions (left/right or forwards/backwards) about the vehicle are given, these must be understood as regarding an occupant in the driver's seat. Special cases not complying with this rule will be specified as appropriate in the text. The figures in the Owner Handbook are provided by way of example only: this might imply that some details of the image do not correspond to the actual arrangement of your car. In addition, the Handbook has been conceived considering vehicles with steering wheel on the left side; it is therefore possible that on vehicles with steering wheel on the right side, the position or construction of some controls is not exactly mirror-like with respect to the figure.

To identify the chapter with the information needed you can consult the index at the end of this Owner Handbook.

Chapters can be rapidly identified with dedicated graphic tabs, at the side of each odd page. A few pages further there is a key for getting to know the chapter order and the relevant symbols in the tabs. There is in any case a textual indication of the current chapter at the side of each even page.

## IMPORTANT NOTES AND PRECAUTIONS

While reading this Owner Handbook you will find a series of **WARNINGS** to prevent procedures that could damage your vehicle.

There are also **PRECAUTIONS** that must be carefully followed to prevent incorrect use of the components of the car, which could cause accidents or injuries.

Therefore all **WARNINGS** and **PRECAUTIONS** must always be carefully followed. **IMPORTANT NOTES** and **PRECAUTIONS** are recalled in the text with the following symbols:



personal safety;











vehicle safety;



environmental protection.

**NOTE** These symbols, when necessary, are indicated besides the title or at the end of the line and are followed by a number. That number recalls the corresponding warning at the end of the relevant section.



<b>GETTING TO KNOW YOUR CAR</b>	
<b>KNOWING THE INSTRUMENT PANEL</b>	
<b>SAFETY</b>	
<b>STARTING AND DRIVING</b>	
<b>IN AN EMERGENCY</b>	
<b>SERVICING AND MAINTENANCE</b>	
<b>TECHNICAL SPECIFICATIONS</b>	
<b>MULTIMEDIA</b>	
<b>CONTENTS</b>	





# GETTING TO KNOW YOUR CAR

*In-depth knowledge of your new car starts here.*

*The handbook you are reading will tell you how things are done, and how it works in a simple, direct way.*

*That's why we advise you to read it seated comfortably on board, so that you can see what is described here for yourself.*

DASHBOARD .....	10
THE KEYS.....	11
IGNITION DEVICE .....	13
FIAT CODE SYSTEM .....	13
DOORS .....	14
SEATS.....	15
HEAD RESTRAINTS .....	18
STEERING WHEEL.....	18
REAR-VIEW MIRRORS .....	19
EXTERNAL LIGHTS .....	20
INTERIOR LIGHTS.....	22
WINDOW WASHING .....	23
MANUAL CLIMATE CONTROL SYSTEM .....	26
AUTOMATIC CLIMATE CONTROL SYSTEM .....	28
ELECTRIC WINDOWS .....	30
ELECTRIC SUNROOF .....	30
SOFT TOP .....	31
BONNET .....	36
BOOT .....	37
INTERIOR FITTINGS .....	38
ROOF RACK/ SKI RACK .....	40
FIRE EXTINGUISHER.....	40
AUDIO SYSTEM.....	41
PROTECTING THE ENVIRONMENT .....	41

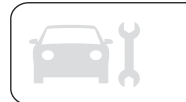

## DASHBOARD

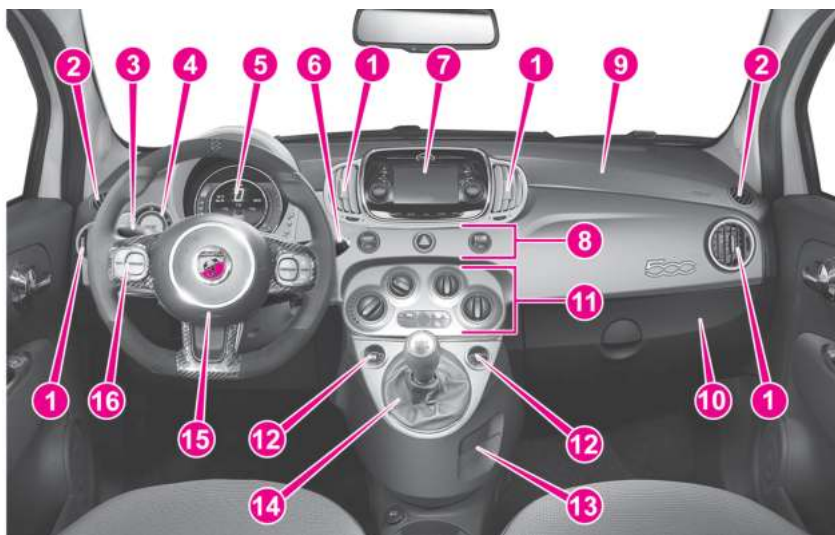

I

AB0A0363C

1. Adjustable air vents 2. Fixed air vents 3. Left stalk: direction indicators, dipped beam headlights, main beam headlights, Lane change function 4. Turbo pressure gauge, "SPORT" display 5. Instrument panel 6. Right stalk: windscreen washer/wiper, rear window washer/wiper 7. **Uconnect™** multimedia system 8. "SPORT" mode, emergency lights, front/rear fog lights 9. Passenger front airbag 10. Glove compartment 11. Climate control system buttons 12. Electric windows 13. Storage compartment 14. Transmission 15. Front driver side airbag 16. **Uconnect™** system steering wheel controls

## THE KEYS

 1) 2)

 1)

### MECHANICAL KEY

The metal insert (1) fig. 2 operates:

- ☐ the ignition device;
- ☐ the door and tailgate locks (where provided);
- ☐ the locking/unlocking of the fuel cap.



2

AB0A0303C

### KEY WITH REMOTE CONTROL

The metal insert (1) fig. 3 operates:

- ☐ the ignition device;
- ☐ the door lock;
- ☐ the locking/unlocking of the fuel cap.

Press button (2) to open the metal insert.

Press button (2) to manually re-close the metal insert.

 3)



3

AB0A0006C

### OPERATION

#### Door and tailgate lock release

Briefly press the button : unlocking of doors and boot, timed switching-on of interior lights and double flashing of direction indicators (where provided). The doors are unlocked automatically if the fuel cut-off system intervenes.

#### Door and tailgate lock

Briefly press the button : locking of doors and boot, switching-off of interior ceiling lights and single flashing of direction indicators (where provided). If one or more door are open, the doors will not be locked. This situation is indicated by a rapid flashing of the direction indicators (where provided). The doors will be locked if the tailgate is open however. When a speed of over 20 km/h is reached, the doors will be automatically

locked if the specific function was set (where provided) with the Setup menu.

### Opening the boot

Press the  button to open the boot remotely.

The direction indicators will flash twice to indicate that the boot has been opened.

### REQUESTING ADDITIONAL REMOTE CONTROLS

The system can recognise up to 8 keys with incorporated remote control. Should a new remote control be necessary, contact an Abarth Dealership and be ready to present the CODE Card (where provided), a personal identity document and the car's ownership documents.

### REPLACING THE BATTERY IN THE KEY WITH REMOTE CONTROL

 1)

To replace the battery, proceed as follows:

- ☐ press button (1) fig. 4 and open the metal insert (2);
- ☐ turn screw (3) to  using a fine bit screwdriver;
- ☐ take out the battery case (4) and replace the battery (5) making sure that polarities are correct;



refit the battery holder (4) inside the key and lock it turning the screw to (3) to .



4

AB0A0007C

## REPLACING THE REMOTE CONTROL COVER

Proceed as shown in fig. 5 to replace the cover of the key with remote control.

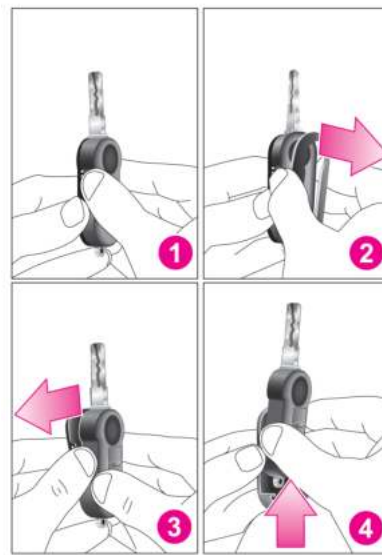

5

AB0A0008C



### WARNING

- 1)** The electronic components inside the key may be damaged if the key is subjected to strong shocks. In order to ensure complete efficiency of the electronic devices inside the keys, they should never be exposed to direct sunlight.
- 2)** Do not swallow the battery. Danger of chemical burns. The keys contain a small battery. If the battery is swallowed, it can cause severe internal burns in just 2 hours

and cause death. Keep new and used batteries out of the reach of children. If the battery compartment does not close securely, discontinue use of the product and keep it out of reach of children. If you believe that batteries may have been swallowed or inserted inside the body, seek medical attention immediately. The emergency key (where provided) must be immediately inserted into the electronic key to prevent easy access to the battery.

**3)** Press button (2) fig. 3 only with the key away from your body, especially your eyes and from objects which could get damaged (e.g. your clothes). Do not leave the key unattended to avoid the button being accidentally pressed while it is being handled, e.g. by a child.



### IMPORTANT

- 1)** Used batteries may be harmful to the environment if not disposed of correctly. They must be disposed of as specified by law in the special containers or taken to an Abarth Dealership, which will take care of their disposal.

## IGNITION DEVICE

### OPERATION

The key can be turned to three different positions fig. 6:

- ☐ STOP: engine off, key can be removed, steering column locked. Some electrical devices (e.g. **Uconnect™**, central door locking system, alarm, etc.) are enabled;
- ☐ MAR: driving position. All electrical devices are enabled;
- ☐ AVV: engine starting.

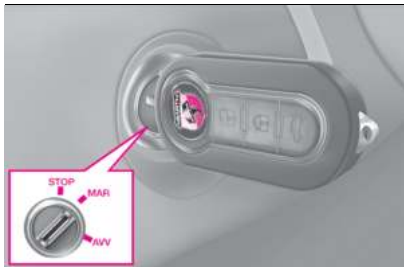

6

AB0A0302C

The ignition device is fitted with a safety system that requires the ignition key to be turned back to STOP if the engine does not start, before the starting operation can be repeated.

 4) 5) 6) 7)

## STEERING LOCK

### Activation

When the device is at STOP, remove the key and turn the steering wheel until it locks.

### Deactivation

Move the steering wheel slightly as you turn the ignition key to MAR-ON



### WARNING

**4)** If the ignition device has been tampered with (e.g. an attempted theft), have it checked over by an Abarth Dealership before driving again.

**5)** Always remove the key when you leave your car to prevent someone from accidentally operating the controls. Remember to engage the handbrake.

Engage 1<sup>st</sup> gear if the car is parked uphill or reverse if the car is parked downhill. Never leave children unattended in the car.

**6)** Never remove the key while the car is moving. The steering wheel will automatically lock as soon as it is turned. This holds true for cars being towed as well.

**7)** It is absolutely forbidden to carry out any after-market operation involving steering system or steering column modifications (e.g.: installation of anti-theft device) that could badly affect performance and safety, invalidate the warranty and also result in non-compliance of the car with type-approval requirements.

## FIAT CODE SYSTEM

The Fiat Code system prevents unauthorised use of the car, disabling engine starting.

### OPERATION

Each time the car is started by turning the ignition key to MAR, the Fiat CODE system control unit sends a recognition code to the Powertrain Control Module to deactivate the immobiliser.

The code is sent only if the Fiat CODE system control unit has recognised the code transmitted from the key.

Each time the ignition key is turned to STOP, the Fiat CODE system deactivates the functions of the engine control module.

### IRREGULAR OPERATION



If, during starting, the code is not correctly recognised, the  icon appears on the display.

In this case, turn the key to STOP and then to MAR; if it is still locked, try again with the other keys that come with the car. Contact an Abarth Dealership if you still cannot start the engine.

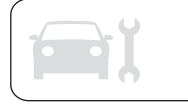
WARNING Each key has its own code which must be stored by the system's control unit. Contact an Abarth



Dealership to have new keys (up to 8) stored with a code.

If the  symbol appears, along with a dedicated message, this means that the system is running a self-diagnosis (for example for a voltage drop). If the  symbols remains on, contact an Abarth Dealership.

## DOORS



### DOOR CENTRAL LOCKING/UNLOCKING

#### Door unlocking from the outside

Press the  button on the key or turn the metal insert (located inside the key) to position (A) fig. 7 in the driver side door lock.

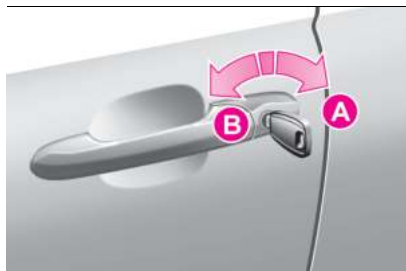

7

AB0A0041C

When the key is turned the doors and the tailgate are simultaneously unlocked.

#### Locking from the outside

With the doors closed, press the  button on the key or fit and then turn the metal insert (located inside the key) to position (B) fig. 7 in the driver side door lock.

**WARNING** If one of the doors is not completely closed or if there is a fault in the system, the central locking will not be activated. If the operation is repeated 10/11 times in quick succession, the device is excluded for approximately 30 seconds.

#### Door unlocking from the inside

To unlock from inside (door and tailgate locks) pull handle (1) fig. 8 (position A).

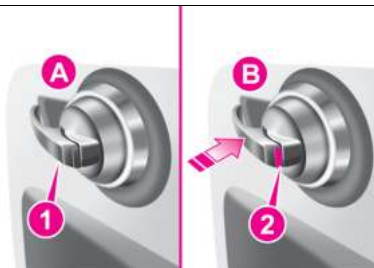

8

AB0A0425C

#### Door locking from the inside

To lock the doors and tailgate from the inside, push handle (1) fig. 8 towards the door panel (position B).

Operating the handle on driver or passenger side locks both doors and tailgate.

The correct lever position with locked doors is shown by the red (2) symbol, visible on the handles.



### WARNING

**8)** Before opening a door, ensure that you can do it in conditions of safety. Open the doors only when the car is stationary.



### IMPORTANT

**1)** Make sure to take the key with you once a door or the tailgate is locked, to prevent locking the same key inside the car. If the key is locked inside, it can only be retrieved by using the second key provided.

# SEATS

## FRONT SEATS

### Lengthwise adjustment

Lift lever (1) fig. 9 and push the seat forwards or backwards: in the driving position, you should be able to rest your arms on the rim of the steering wheel.

 9) 10) 11)

 2)

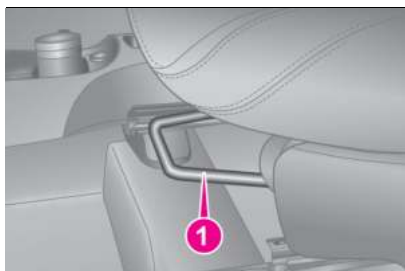

9

AB0A0010C

### Height adjustment

(where provided)

Move lever (3) fig. 10 up or down until the required height is reached.

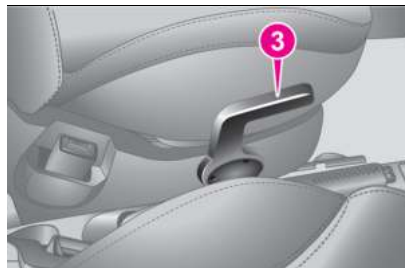

10

AB0A0012C

### Backrest angle adjustment

Turn knob (2) fig. 11 until the required position is reached.

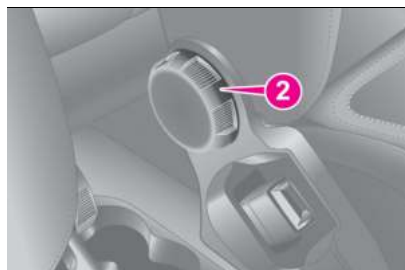

11

AB0A0011C

### Reclining the backrest

 3)

To fold the backrest over, adjust lever (4) fig. 12 (movement A) and push the backrest forwards until it locks (movement B).

Then release lever (4) and, pushing on the backrest, slide the seat forward (movement C).

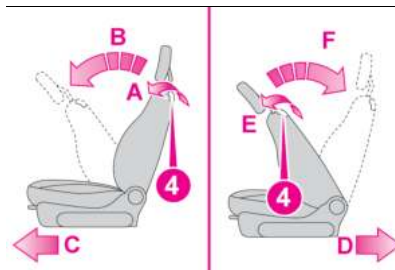

12

AB0A0013C

### Driver side and passenger side, with position memory

To bring back the seat in its initial position proceed as follows:

- ☑ slide the seat backwards pushing on the backrest, until the seat is locked (movement E);
- ☑ adjust lever (4) fig. 12 (movement E);
- ☑ raise the backrest (movement F) until you hear the lock click.

**WARNING** Using lever (4) fig. 12 before locking the seat in its initial position will cause the initial seat position to be lost. In this case the position of the seat must be restored through lengthwise adjustment lever (1) fig. 9.



### Passenger side without position memory

To bring back the seat in its initial position proceed as follows:

- ▣ slide the seat backwards pushing on the backrest to the desired position (movement D);
- ▣ adjust lever (4) fig. 12 (movement E);
- ▣ raise the backrest (movement F) until you hear the lock click. The type of reattachment manoeuvre has been chosen to guarantee the safety of the occupant. In fact, if there is an obstacle (e.g. a bag) that prevents the seat from returning to its start position, just using lever (4) the mechanism guarantees that the seat is fastened to its guides.

### SPORT FRONT SEATS

#### Lengthwise adjustment

Lift lever (1) fig. 13 and push the seat forwards or backwards: in the driving position, you should be able to rest your arms on the rim of the steering wheel.



9) 11)

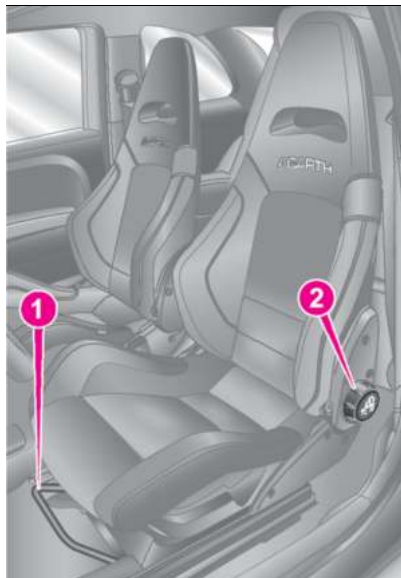

13

AB0A0015C

#### Backrest angle adjustment

Turn knob (2) fig. 13 until the required position is reached.

#### Reclining the backrest



9)

To fold the backrest over, pull the lever (3) fig. 14 (on the seat back) upwards; then release it and, pushing on the backrest, slide the seat forward.

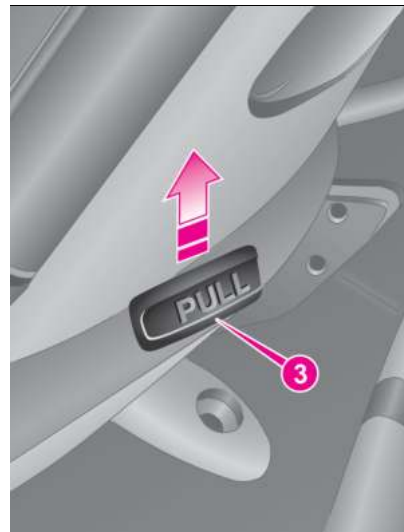

14

AB0A0016C

### REAR SEATS

#### Extending the boot



12)

The separate rear seats allow partial fig. 15 or total fig. 16 luggage compartment extension.



15

AB0A0049C



16

AB0A0050C

### Partial extension (50/50)

(where provided)

Proceed as follows:

- ☐ remove the rear seat head restraints (where provided);
- ☐ remove the parcel shelf, by releasing it from its two side pins and pulling it out.
- ☐ check that the seat belt is fully extended and not twisted

☐ operate lever (1) or (2) fig. 17 to release the left hand or right hand part of the backrest respectively and guide it onto the cushion.

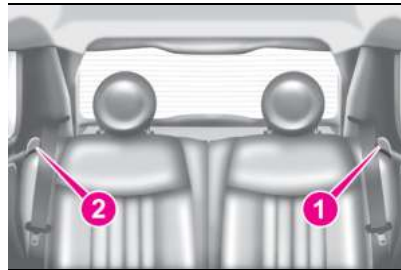

17

AB0A0014C

**WARNING** To return the backrest to its correct position, we recommend operating from the outside through the doors.

### Total extension

Tilting the rear seat completely forwards allows maximum loading volume. Proceed as follows:

- ☐ remove the rear seat head restraints (where provided)
- ☐ remove the parcel shelf, by releasing it from its two side pins and pulling it out.
- ☐ check that the belt straps are correctly extended and not twisted

☐ operate the levers (1) and (2) fig. 17 to release the backrests and guide them onto the cushion.

### Repositioning the rear seat

Raise the backrests and push them back until the locking click of both retainers is heard.

Position the seat belt buckles upwards and set the cushion to the normal use position.

**WARNING** To return the backrest to its correct position, we recommend operating from the outside through the doors.

**WARNING** When returning the backrest to its normal position, make sure that it is correctly fastened and that you hear the lock click. Make sure the backrest is properly secured at both sides to prevent it moving forward in the event of sharp braking that may cause injuries to passengers.



### WARNING

**9)** All adjustments must be made with the car stationary.

**10)** If a side bag is fitted, it is dangerous to use seat covers not available from Lineaccessori Abarth.



**11)** After releasing the adjustment lever, always check that the seat is locked on the guides by trying to move it back and forth. If the seat is not locked into place, it may unexpectedly slide and cause the driver to lose control of the car.

**12)** Make sure the backrests are properly secured at both sides to prevent them from moving forward, in the event of sharp braking, with possible impact with of the passengers.



### IMPORTANT

**2)** The fabric upholstery of the seats has been designed to withstand long-term wear deriving from normal use of the car. Some precautions are however required. Avoid prolonged and/or excessive rubbing against clothing accessories such as metal buckles and Velcro strips which, by applying a high pressure on the fabric in a small area, could cause it to break, thereby damaging the upholstery.

**3)** Before tilting the backrest, remove any objects on the seat cushion.

## HEAD RESTRAINTS

### REAR

(where provided)

To extract the rear head restraints press buttons (2) and (3) fig. 18 at the side of the two supports simultaneously and lift them out upwards.

The rear head restraints must be lifted out with the backrest released and tilted toward the passenger compartment or with the tailgate open. To bring the head restraint to the correct position, lift it until you hear it click.

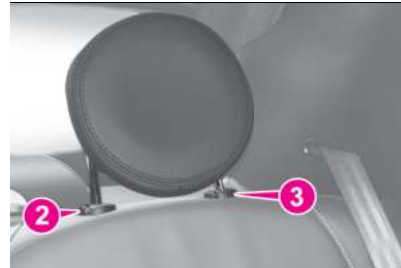

18

AB0A0017C

To lower the head restraint, press button (2) fig. 18.

**WARNING** If the rear seats are used, always set the head restraints in the "completely raised" position.

## STEERING WHEEL

The steering wheel can be adjusted vertically.

To adjust bring the lever fig. 19 downward in position (B), then adjust the steering wheel to the most suitable position and lock it in this position bringing the lever in position (A).

**13) 14)**

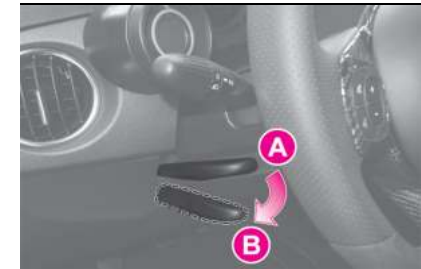

19

AB0A0018C



### WARNING

**13)** All adjustments must be carried out only with the car stationary and engine off.

**14)** It is absolutely forbidden to carry out any after-market operation involving steering system or steering column modifications (e.g.: installation of anti-theft device) that could badly affect performance and safety, invalidate the warranty and also result in non-compliance of the car with type-approval requirements.

## REAR-VIEW MIRRORS

### INTERIOR MIRROR

The mirror is fitted with a safety device that causes its release in the event of a violent impact with the passenger.

Lever (1) fig. 20 can be used to move the mirror to two different positions: normal or anti-glare.



20

AB0A0019C

### ELECTROCHROMIC REAR-VIEW MIRROR

(where provided)

Some versions have an electrochromic mirror with automatic antiglare function.

There is an ON/OFF button on the lower part of the mirror for activating/deactivating the electrochromic function. When the function is active, a LED on the mirror is active. When reverse is engaged, the mirror is automatically set for daytime use.

## DOOR MIRRORS

Proceed as follows:

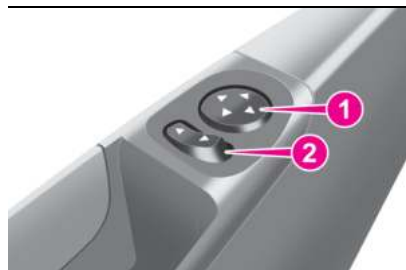

21

AB0A0020C

- ☐ select the mirror using selector (2) fig. 21;
- ☐ adjust the mirror using the joystick (1) fig. 21 in the four directions.

### Folding the mirrors

When required (for example when the mirror causes difficulty in narrow spaces ) it is possible to fold the mirrors manually moving them from the open position (A) to the closed position (B) fig. 22.



15) 16)



22

AB0A0021C



### WARNING

**15)** When driving, these mirrors must always be in the open position.

**16)** As door mirrors are curved, they may slightly alter the perception of distance.



## EXTERNAL LIGHTS

### DAYTIME RUNNING LIGHTS (DRL) "Daytime Running Lights"

(where provided)

For cars without the AUTO function: with the ignition key at MAR and ring fig. 23 turned to , the daytime running lights switch on.

The other lights and interior lighting stay off.

For vehicles with the AUTO function: the daytime running lights are turned on automatically by the dusk sensor when the ring is in the AUTO position.



23

AB0A0026C





### DIPPED HEADLIGHTS/SIDE LIGHTS

With the ignition key turned to MAR, turn the twist switch to  fig. 23. If dipped headlights are activated, the

daytime running lights switch off and the side lights and dipped headlights switch on.

The  warning light switches on in the instrument panel.

When the ignition key is turned to STOP or removed and the twist switch is turned from  to , all the side lights and number plate lights come on. With the selector switch in the AUTO position, the side lights and the dipped beam headlights are controlled by the dusk sensor.

### MAIN BEAM HEADLIGHTS

To activate the main beam headlights, with the ring at , pull the stalk towards the steering wheel beyond the end of travel click.

The  warning light switches on in the instrument panel.



For vehicles with the AUTO function: with the ring in the AUTO position and the dipped beam headlights on, push the stalk forwards toward the dashboard.



When the stalk is pulled towards the steering wheel again, beyond the end of travel position, the main beam headlights deactivate, the dipped headlights reactivate and the  warning light switches off.

### Flashing the headlights

To do this, pull the stalk towards the steering wheel (unstable position) fig. 23 regardless of the position of ring. The  warning light switches on in the instrument panel.

### DIRECTION INDICATORS

Bring the stalk to the (stable) position:  up (position A) fig. 23: activates the right direction indicator;  down (position B): activates the left direction indicator.

Warning light  or  will blink on the instrument panel. The direction indicators are switched off automatically when the steering wheel is straightened.

### "FOLLOW ME HOME" DEVICE

This allows the space in front of the car to be lit for a set time.

#### Activation

With the ignition key in the STOP position or extracted, pull the lever towards the steering wheel and move it within 2 minutes of the engine switching off.

At each single movement of the stalk, the lights will remain on for an extra 30 seconds up to a maximum of 210 seconds: then the lights are switched off automatically. The display shows

the time for which the functions remains active.

The  warning light on the instrument panel switches on when the stalk is pulled for the first time and stays lit until the function switches off automatically.

### Deactivation

The function is deactivated by turning the headlights or the side lights on, or by pulling the left lever towards the steering wheel (unstable position) for more than 2 seconds, or by turning the ignition device to MAR.

### AUTO FUNCTION

(for versions/markets, where provided)

#### Dusk sensor

This is an infrared LED sensor that works in conjunction with the rain sensor and is located on the windscreen. It is able to detect variations in outside lighting based on the light sensitivity set in the display Menu or the **Uconnect™** 5" or 7" HD system (where provided).

#### Function activation

Turn the left stalk ring (A) fig. 24 to the **AUTO** position.

**WARNING** The function can only be activated with the ignition device at MAR.

### Function deactivation

To deactivate the function, turn the left stalk ring (A) to position .



24

AB0A0610

### FOG LIGHTS / REAR FOG LIGHTS

(where provided)

The fog lights can be activated only when the dipped beam headlights are on.

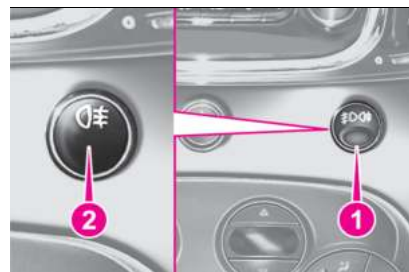

25

AB0A0352C

To turn on the front/rear fog lights, use button (1) fig. 25 as follows:

 **first pressing:** front fog lights on;

 **second press:** rear fog lights on;

 **third press:** front/rear fog lights off.

With front fog lights on, the  warning light on the instrument panel will come on at the same time.

With rear fog lights on, the  warning light on the instrument panel will come on at the same time.

### REAR FOG LIGHTS

When the dipped beam headlights are on, these can be activated by pressing button (2)  fig. 25.

With lights on, the warning light  on the instrument panel will come on at the same time.

Press the button again to switch the lights off.

### LIGHT BEAM DIRECTION

The correct aiming of the headlights is important for the comfort and safety of not only the driver but all other road users.

This is also covered by a specific rule of the highway code.

The headlights must be correctly aimed to guarantee the best visibility conditions for all drivers while travelling with headlights on.

Contact an Abarth Dealership to have the fog lights properly adjusted.

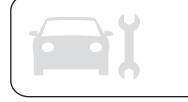

Check light beam alignment every time the load or its distribution changes.

**WARNING** When the gas discharge (Xenon) headlights (where provided) are switched on, normally parabolas and light beam move vertically for about 2 seconds until headlight alignment has stabilised.

## HEADLIGHT ALIGNMENT CORRECTOR



26

AB0A0002C

With the ignition key in the MAR position and the dipped headlights on, press the **+** or **-** fig. 26 buttons to adjust the headlight alignment.

The adjustment positions are shown on the display.

Position 0 - one or two people in the front seats.

Position 1 - 4 passengers.

Position 2 - 4 passengers + load in the boot.

Position 3 - driver + maximum permitted load stowed in the boot.

**WARNING** Gas discharge headlights (Xenon headlights) are automatically adjusted. Headlight alignment adjustment is electronic and therefore cannot be manually adjusted using the **+** and **-** buttons.

## FOG LIGHTS ALIGNMENT

(where provided)

Contact an Abarth Dealership to have the fog lights properly adjusted.

## ADJUSTING THE HEADLIGHTS ABROAD

Dipped beam headlights are adjusted for driving in the country where the vehicle was originally purchased. When travelling in countries with opposite driving direction, to avoid dazzling the drivers on the other side of the road, you need to cover areas of the headlight according to the Highway Code of the country you are travelling in.



## WARNING

**17)** *The daytime running lights are an alternative to the dipped headlights while driving during the daytime in countries where it is compulsory to have lights on during the day; where it is not compulsory, the use of daytime running lights is permitted.*

**18)** *Daytime running lights cannot replace dipped beam headlights when driving at night or through tunnels. The use of daytime running lights is governed by the highway code of the country in which you are driving. Comply with legal requirements.*

## INTERIOR LIGHTS

### FRONT CEILING LIGHT

The fig. 27 lens can be set to three positions:

- right side pressed*: light always on;
- left side pressed*: light always off;
- central position (neutral)*: the light switches on and off when the doors are opened or closed.



27

AB0A00282C

**WARNING** Before getting out of the car, make sure that the switch is in the central position: ensure that lights are off with doors closed in order to avoid running the battery down.

On some versions, the lights switch on and off only when the front driver side door is opened or closed.

When the doors are released using the key with remote control, a timer will be activated for about 10 seconds. When the doors are locked using the key with remote control, the ceiling light switches off.

### Ceiling light timing (lens central position)

The ceiling light automatically turns on in the following cases: on opening the door, on removing the key from the ignition switch and on unlocking the doors.

The ceiling light turns off 10 seconds after closing all the doors and on locking the doors. The interior lights are switched off in any case after 15 minutes to preserve battery charge.

## WINDOW WASHING

The right stalk controls screen wiper/washer operation.

This operates only with the ignition key turned to MAR.

## WINDSCREEN WIPER/WASHER

### Operation

 19) 20)

 4) 5)

The stalk has five different positions (4 speeds) fig. 28:



28

AB0A0028C

- ☐ A: windscreen wiper off.
- ☐ B: intermittent operation.
- ☐ C: continuous slow operation.

- ☐ D: continuous fast operation.
- ☐ E: temporary fast operation (unstable position).

The temporary fast function lasts as long as you manually keep the stalk in that position.

The lever returns to position A when it is released, automatically stopping the windscreen wipers.

## WINDSCREEN WIPERS WITH AUTOMATIC WIPING

The stalk can be put in four different positions fig. 29:

- ☐ A - windscreen wiper stationary (0)
- ☐ B - automatic wiping (AUTO)
- ☐ C - slow continuous operation (LO)
- ☐ D - fast continuous operation (HI)
- ☐ E - temporary fast operation (unstable position).

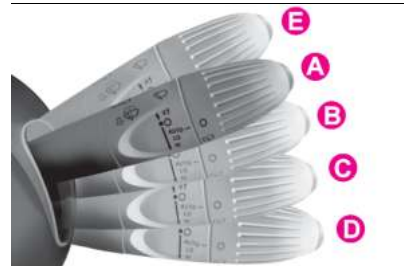

29

AB0A00611

 6)

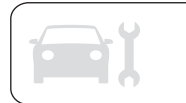

In case of direct passage from position (B) to position (E), when the lever is released it returns to position (A).

### “Smart washing” function

Pull the stalk towards the steering wheel (unstable position) to operate the windscreen washer.

Keep the lever pulled to activate both the windscreen washer jet and the windscreen wiper with a single movement; the latter turns on automatically if you keep the lever pulled for more than half a second.

The operation of the windscreen wiper terminates several strokes after the stalk is released; a final cleaning stroke several seconds later completes the wiping operation.

### REAR WINDOW WIPER/WASHER

#### Operation



This operates only with the ignition key turned to MAR. Turn the ring to  to operate the rear window wiper.

With the windscreen wiper active, turn the ring to  to activate the rear window wiper which, in this case, operates (in the different positions) in synchronisation with the windscreen wiper, but with half its frequency. With the windscreen wiper on, engaging reverse gear will automatically turn the

rear window wiper on, in continuous slow operation. Operation stops when reverse gear is disengaged.

### “Smart washing” function

Pushing the stalk towards the dashboard (spring-return position) will activate the rear window washer.

Keep the stalk pressed, with just one movement, to operate the rear window washer jet and the rear window wiper itself; the latter automatically turns on if you keep the stalk pressed for more than half a second.

The rear window wiper stops operating a few strokes after releasing the stalk; a further "cleaning stroke", after a few seconds, completes the wiping operation.

### RAIN SENSOR

(for versions/markets, where provided)

The sensor will be activated when the ignition device is turned to MAR, and will be deactivated in the STOP position.

This is a device located behind the interior rear view mirror, in contact with the windscreen and can measure the amount of rain and, consequently, manage the automatic wiping mode of the windscreen in accordance with the amount of water on the screen.

WARNING Keep the window clean in the sensor area.

### AUTOMATIC WIPING

(for versions/markets, where provided)



#### Activation

The user can select automatic wiping by moving the right steering wheel stalk to the AUTO (B) position. The activation of the automatic wiping will be notified to the driver by a single stroke.

#### Sensitivity Adjustment

The rain sensor sensitivity can be adjusted through the display menu or on the .Uconnect™ 5" or 7" system.

#### Inhibition

If the starter switch is moved to the STOP position, leaving the right steering wheel stalk in the AUTO (B) position, when the vehicle is next started (starter switch in the MAR position), no wiping cycle to prevent damage to the system if the windscreen is being washed manually or if there is ice on it.

To re-enable the automatic wiping mode:

 Put the right steering wheel stalk in a position other than AUTO and then back to the AUTO position;

▮ exceed the speed of 5 km/h when the sensor detects rain.

### Deactivation

The user can disable automatic wiping by moving the right steering wheel stalk to a position other than AUTO.



#### WARNING

**19)** If the window needs to be cleaned, make sure the device is turned off or the key is on STOP.

**20)** Driving with worn windscreen/rear window wiper blades is a serious risk, because visibility is reduced in bad weather.



#### IMPORTANT

**4)** Never use the screen wiper to remove layers of snow or ice from the windscreen glass. In such conditions, the wiper may be subjected to excessive stress and the motor cut-out switch, which prevents operation for a few seconds, may intervene. If operation is not subsequently restored, contact an Abarth Dealership.

**5)** Do not operate the windscreen wiper with the blades lifted from the windscreen.

**6)** Do not activate the rain sensor or the rear window wiper when washing the car in an automatic car wash.

**7)** Do not use the rear window wiper to remove layers of snow or ice. In these conditions, the rear window wiper may be subjected to excessive stress and

*the motor protection, which prevents operation for a few seconds, may intervene. If operation is not subsequently restored, contact an Abarth Dealership.*

**8)** Make sure the device is switched off if there is ice on the windscreen glass.



## MANUAL CLIMATE CONTROL SYSTEM

(where provided)  
CONTROLS



### 1. Air temperature knob

- ☐ Red section: hot air;
- ☐ Blue section: cold air.

### 2. Fan speed/climate control on and off knob

Press the knob to activate the climate control system; the LED on the knob switches on. This enables rapid cooling of the passenger compartment.

NOTE To stop the air flow from the vents turn the knob to 0.



### 3. Air recirculation knob

- internal air recirculation
- air intake from outside

**WARNING** It is advisable to switch the air recirculation on whilst queueing or in tunnels to prevent the introduction of polluted air. However, it is better not to use the function for long periods, particularly if there are many people on board, to prevent the windows from misting.

### 4. Air distribution knob

- air flow to central and side dashboard vents to ventilate the chest and the face during the hot season.
- distribution between feet area vents (warmest air) and dashboard vents (coolest air).

towards the footwell vents. Due to the natural tendency of heat to spread upwards, this type of distribution warms the passenger compartment up as quickly as possible, providing an immediate feeling of warmth.

distribution between footwell vents and windscreen/front side window vents. This type of distribution achieves effective heating of the passenger compartment and prevents the windows from misting up.

air flow to the windscreen and front side window vents to demist or defrost them.

**WARNING** In warm-humid weather conditions, using cold air on the windscreen may cause external condensation, which could limit visibility.

### 5. Heated rear window activation and deactivation button

The LED on the button switches on to indicate activation.

In order to maintain battery efficiency, the function is automatically deactivated after about 20 minutes.

### Fast windscreen and front side window demisting and defrosting (MAX-DEF)

Proceed as follows:

- ☐ turn knob (1) to the red section;
- ☐ turn knob (3) to ;
- ☐ turn knob (4) to ;
- ☐ turn the knob (2) to (4) (fan maximum speed).

### SYSTEM SERVICING

In winter, the climate control system must be turned on at least once a month for about 10 minutes. Have the system inspected at an Abarth Dealership before the summer.



#### IMPORTANT

**2)** The system uses a coolant that is compatible with the laws in force in countries where the vehicle is sold, R134a or R1234yf. When charging, only use the gas indicated on the dedicated plate in the engine compartment. The use of other coolants affects the efficiency and condition of the system. The lubricant used for the compressor is also strictly linked to the refrigerant gas type, refer to the Abarth Dealership.

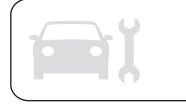

## AUTOMATIC CLIMATE CONTROL SYSTEM

(where provided)  
CONTROLS







Depending on the temperature set by the user, the automatic climate control system automatically regulates the temperature, flow and distribution of the passenger compartment air, as well as the recirculation function. These settings can be changed by the user, putting the climate control system in manual mode (the LED on the AUTO 1 fig. 31 button turns off).





☐ (1) AUTO button: automatic climate control function on

☐ (2) Button : climate control system compressor on or off. The LED on the button is on when the compressor is turned on.

☐ (3) OFF button: turns the climate control system off

☐ (4) Button : air recirculation on or off. It is inadvisable to use air recirculation when the outside temperature is low, since the windows could mist rapidly.

☐ (5) Buttons  : temperature setting. Pressing the  button increases the passenger compartment temperature, pressing the  button decreases it. If the heating fluid temperature is not sufficiently high, the maximum fan speed does not come on straight away in order to limit the intake of insufficiently hot air into the passenger compartment.

☐ (6) Buttons  : fan speed adjustment. Pressing the  button increases the passenger compartment air flow, pressing the  button decreases it.

☐ (7) Button : directs air flow to the windscreen and front side window vents to demist or defrost them.

☐ (8) Button : directs air flow to the central and side dashboard vents to ventilate the body and face during the hot season.

☐ (9) Button : directs air flow to the front seat feet area vents. Due to the natural tendency of heat to spread upwards, this type of distribution warms the passenger compartment up as quickly as possible, providing an immediate feeling of warmth.

☐ (10) Button : heated rear window demisting/defrosting.

**WARNING** Do not apply stickers on the inside of the rear window over the heating filaments to avoid damage.

☐ (11) Button : front window fast demisting/defrosting. The function remains active for approximately 3 minutes after the coolant temperature exceeds 50°C.

**WARNING** In warm-humid weather conditions, using cold air on the

windscreen may cause external condensation, which could limit visibility.

## SYSTEM SERVICING

In winter, the climate control system must be turned on at least once a month for about 10 minutes.

Have the system inspected at an Abarth Dealership before the summer.



### IMPORTANT

**3)** *The system uses a coolant that is compatible with the laws in force in countries where the vehicle is sold, R134a or R1234yf. When charging, only use the gas indicated on the dedicated plate in the engine compartment. The use of other coolants affects the efficiency and condition of the system. The lubricant used for the compressor is also strictly linked to the refrigerant gas type, refer to the Abarth Dealership.*

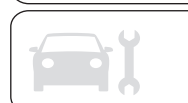

## ELECTRIC WINDOWS



21) 22)

Turn the ignition key to the MAR position and press the following buttons:

1. Opening/closing of the left window.
2. Opening/closing of the right window.



32

AB0A0225C



### WARNING

**21)** *Improper use of the electric windows can be dangerous. Before and during operation, always check that nobody is exposed to the risk of being injured either directly by the moving window or through objects getting caught or hit by it.*

**22)** *When leaving the car, always remove the ignition key to avoid the risk of injury for people still on board due to accidental operation of the electric windows.*

## ELECTRIC SUNROOF

(where provided)

### Sunshade

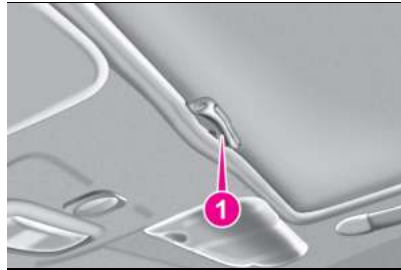

33

AB0A0039C

Press the catch (1) fig. 33 and guide the blind until it is completely open. To close it, grab the grip and move the blind to the closed position until catch (1) is attached.

### Opening and closing the roof

With the ignition key in the MAR position:

☐ Opening: press the button (1) fig. 34 and hold it down: the roof will move to the "spoiler" position. To fully open the roof press button (1) again and hold it down: the roof will stop in the position reached when the button is released.

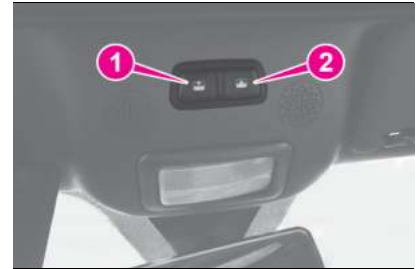

34

AB0A0287C

☐ To close: Press button (2) fig. 34 and hold it down: the roof will move to the "spoiler" position. The roof will stop in the position reached when the button is released. Press button (2) again and hold it down until the roof is completely closed.



9) 10)



23)

### ANTI-PINCH DEVICE

The sunroof has an anti-pinch safety system capable of detecting the presence of an obstacle whilst the roof is closing. When this happens, the system stops and the movement of the roof is immediately reversed.

### INITIALISATION PROCEDURE

The sunroof must be re-initialised after disconnecting the battery or if the relevant protection fuse is blown.

Proceed as follows:

- ☐ keep the button (2) fig. 34 pressed so that the roof closes completely in stages
- ☐ after full closing, wait for the sunroof motor to stop.

## EMERGENCY OPERATION

If the electrical device for moving the roof fails, the sunroof can be moved manually proceeding as described below:

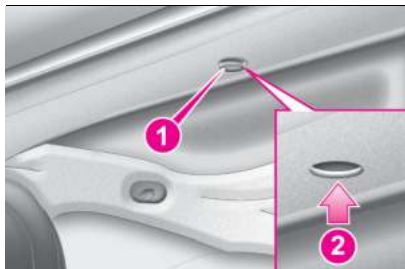

35

AB0A0040C

- ☐ for manual activation remove the protective cap (1) fig. 35 from its housing which is located on the internal covering behind the sunshade
- ☐ take the hex wrench provided from the tool bag in the boot
- ☐ insert the key provided into the slot (2) and turn it clockwise to open the roof or anticlockwise to close the roof.



## WARNING

**23)** When leaving the car, always remove the key from the ignition device to avoid the risk of injury to those still inside the car due to accidental operation of the sunroof. Improper use of the roof can be dangerous. Before and during operation, always check that no-one is exposed to the risk of being injured by the moving sunroof or by objects getting caught or hit by it.



## IMPORTANT

**9)** Do not open the sunroof if there is snow or ice on it: you may damage it.  
**10)** You are advised to use the sunroof only at "spoiler" position if a transverse roof rack is fitted.

## SOFT TOP

(where provided)

The 595C version is provided with an automatically actuated electric soft top. The top can be opened and closed using the controls inside the car located near the ceiling light fig. 38 or the remote control buttons (while opening and for the horizontal part only).

The soft top can be automatically opened from the closed position to the spoiler position fig. 36, and from this position to the fully open position fig. 37.



36

AB0A0293C





37

AB0A0284C

### Suggestions

- ▣ it is advisable to close the soft top when the car is parked. The closed soft top effectively protects the car from bad weather and from theft;
- ▣ it is advisable to put valuables in the boot and lock the lid even when the soft top is closed.

### SOFT TOP MOVEMENT

 24) 25) 26)

 11) 12) 13)

**WARNING** The motor may overheat if the soft top is repeatedly operated within a short space of time, thus causing the overheating protection to inhibit system operation. Wait for a minute and repeat.

### OPERATION USING THE BUTTONS INSIDE THE CAR

#### Opening from roof fully closed position

Press the button (1) fig. 38 once to open the roof automatically to the horizontal opening position (spoiler position).



38

AB0A0287C

If one of the two buttons is pressed before reaching the spoiler position, the roof may stop in an intermediate horizontal opening position.

#### Opening from top in intermediate horizontal position

From the horizontal intermediate position press the (1) button move the top automatically to the horizontal all open position (spoiler position).

#### Opening roof from spoiler to all open position

From the spoiler position, pressing the (1) button once, the top goes

automatically to the full opening position (vertical opening).

If one of the two buttons is pressed before the final position is reached, the soft top will stop and move back to the initial position (spoiler position).

**WARNING** The vertical opening will be inhibited when the tailgate is open.

**WARNING** If the soft top locks during its movement, it may lose the position; in this case, you should carry out a complete opening / closing cycle.

#### Closing the roof from top fully open position

Press the button (2) fig. 38 once to automatically close the roof to spoiler position (vertical section closing). If one of the two buttons is pressed before the spoiler position is reached, the roof will stop and movement will be reversed, moving to the initial position (all open).

#### Initial condition: from spoiler position to top all closed

Press the “one-touch” button (2) fig. 38 in spoiler position to bring the top automatically to safety position (approximately 25 cm from fully closed position).

If one of the two buttons is pressed before the stop position is reached, the soft top may stop in an intermediate horizontal open position.

**NOTE** The top will not automatically close completely; keep button (2) pressed to close the roof completely. The roof will stop instantly if the button is released before the all closed position is reached.

### Initial condition: from intermediate position to top all closed

Press the button (2) fig. 38 in the horizontal intermediate position to bring the roof automatically to the safety position (approximately 25 cm from horizontal all closed position). Keep the button (2) fig. 38 pressed to close the roof completely. The roof will stop instantly if the button is released before the all closed position is reached.

### Opening the tailgate with top all open

Press the tailgate opening button (1) fig. 39 once to automatically close the roof to spoiler position. The tailgate can be opened in spoiler position.

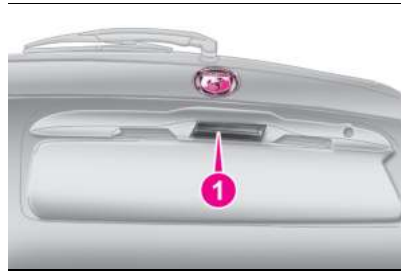

39

AB0A0045C

### OPERATION BY MEANS OF REMOTE CONTROL

The remote control can only be used with the engine off and the doors closed.

**NOTE** The remote control can be used to open the roof to the horizontal open position (spoiler position). Continuously pressing the "release" button (1) fig. 40, the roof opens and stops in any position when the button is released.



40

AB0A0332C

### WARNINGS

- ⚠ The horizontal and vertical parts of the soft top can be operated at any speed lower than 100 and 80 km/h respectively.
- ⚠ The top can be operated at any temperature in the range from -18 to +80°C.
- ⚠ It is recommended to have the engine running always when opening or closing the soft top.
- ⚠ If required, remove the battery with open or closed soft top, but NOT when the soft top is moving.
- ⚠ Do not fix roof racks to the soft top and do not travel with objects resting on the open top.
- ⚠ The activation of the heated rear windscreen, upon request by the user, is carried out only if the soft top is completely closed. If the soft top is closed incorrectly, the heated rear window will not function and the corresponding warning light will not turn on.
- ⚠ Do not remove ice from the soft top with a sharp item.
- ⚠ To prevent damage, do not use scrapers or sprays to remove ice from the heated rear window.
- ⚠ Do not put objects on the soft top: they could fall if the it is operated, causing damage and injury.



- ▣ It is advisable to cover the soft top with a protective sheet if the car is left parked in the open for a long time.
- ▣ Do not keep the soft top folded for a long time: this could cause folds and creases in the fabric.
- ▣ Before moving the soft top, check that there is enough room to carry out the operation and that there are no obstacles or people close to its moving parts.
- ▣ The cooled air flow into the passenger compartment may decrease if the automatic climate control system is on and the soft top is not completely closed.
- ▣ With the soft top open and the car travelling, the voice recognition system may not recognise voice commands because of the background noise: with the soft top closed and at a high speed, the voice function for number dialling may not be recognised.

### EMERGENCY OPERATION

If the buttons fail, the soft top can be moved manually proceeding as described below:

- ▣ take the key (1) fig. 41 provided and located in the boot in combination with the tool bag or the Fix&Go kit;

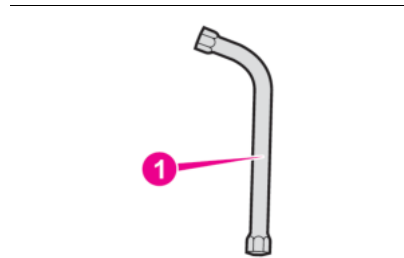

41

AB0A0327C

- ▣ insert the provided key in position, visible from inside the boot beneath the parcel shelf in the point (1) shown in fig. 42;

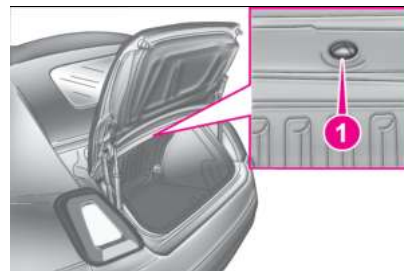

42

AB0A0295C

- ▣ turn: clockwise to open the soft top; anticlockwise to close it.
- If the tailgate fails to open due to the battery being flat, or following an anomaly of the tailgate electric lock, perform an emergency tailgate opening as described in the “boot” paragraph of the “Knowing your car” chapter,

the manually move the soft top as described above.  
To restore automatic movement, contact an Abarth Dealership.

### INITIALISATION PROCEDURE

The soft top must be re-initialised after disconnecting the battery or if the relevant protection fuse is blown.

Proceed as follows:

- ▣ with the ignition device at MAR, keep the opening button pressed until the soft top is completely open;
- ▣ when the soft top is completely open, keep the button pressed for at least 2 seconds;
- ▣ keep the closing button pressed until the soft top is completely closed;
- ▣ once the all closed position has been reached, continue to press the button until the soft top makes a full opening and closing run.

If the soft top is already initialized, the user can perform a new initialisation by the following steps:

- ▣ keep the opening button pressed until the soft top is completely open;
- ▣ when the soft top is completely open, keep the button pressed for at least 30 seconds (to force the loss of initialisation);
- ▣ keep the closing button pressed until the soft top is completely closed;

☐ once the all closed position has been reached, continue to press the button until the soft top makes a full opening and closing run.

## WIND STOP

The Wind Stop fig. 43 is designed to improve driving comfort, by reducing air turbulence in the passenger compartment when travelling with the soft top down.

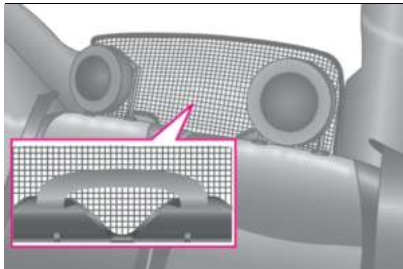

43

AB0A0328C

To use it:

- ☐ Release the backrest of the rear seat (single or split).
- ☐ Attach the Wind Stop by inserting the central part inside the rear screen guard, with the concave part in the direction of the passenger, as shown in fig. 43;
- ☐ re-position the backrest correctly; the Wind Stop is locked between the seat and parcel shelf.

## FRONT SPOILER

The car is provided with a front spoiler which can be raised to improve aerodynamic comfort inside the passenger compartment.

To lift the spoiler, release the catch by means of the slider (1) moving it to position (B) as shown in fig. 44.

With the spoiler raised, take care not to move the slider (1) from position (B) to position (A).

To lower the spoiler, press and move the slider to position fig. 45 to lock it once the slider's catch is positioned inside its housing (A) fig. 44.

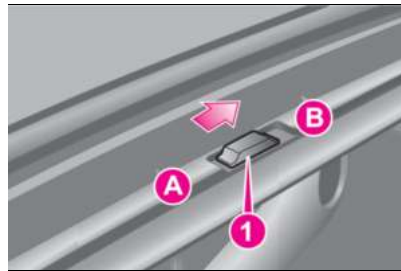

44

AB0A0329C

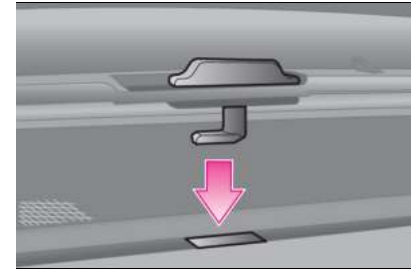

45

AB0A0330C

It is advisable to raise the spoiler when the horizontal segment of the top is open and at speeds faster than 50 km/h.

With the top completely open, it is advisable to keep the spoiler lowered to limit wind noise inside the passenger compartment.

Raising the spoiler will reduce the flow of air to the rear seats.



### WARNING

**24)** Keep hands away from the top mechanism while opening and closing the top or if the top stops in a position before completing the cycle to prevent damage and injury.

**25)** Keep children away from the area in which the top is folding during opening or closing operations.

**26)** When leaving the car, always remove the key from the ignition device to avoid



*the risk of injury due to accidental operation of the soft top: improper use of the roof can be dangerous. Before and during operation, always check that no-one is at risk of being injured by the moving soft top roof or by objects getting caught and dragged by it.*



### IMPORTANT

- 11)** Never open the top in presence of snow or ice to prevent damage.
- 12)** Do not place objects on the rear window shelf to prevent damage while the top is closing.
- 13)** Loads may not be secured on the roof.

## BONNET

### OPENING

Proceed as follows:

- ▣ pull the lever (1) fig. 46 in the direction indicated by the arrow;
- ▣ move the lever (2) fig. 47 to the right as shown in the figure;
- ▣ lift the bonnet and at the same time release the support rod (3) fig. 48 from its catch (4), then insert the rod end into the recess (5) of the bonnet (large hole) and push into the safe position (small hole), as shown.

27) 28) 29) 30)

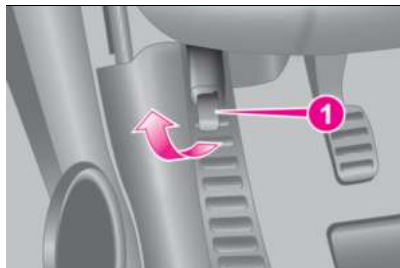

46

AB0A0051C

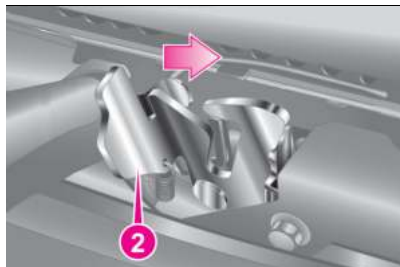

47

AB0A0052C

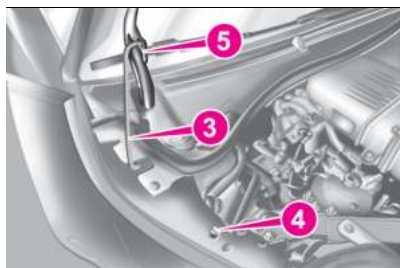

48

AB0A0053C

### CLOSING

Proceed as follows:

- ▣ hold the bonnet up with one hand and with the other remove rod (3) fig. 48 from recess (5) and fit it back into its catch (4);
- ▣ lower the bonnet to approximately 20 centimetres above the engine compartment and let it come down. Make sure that the bonnet is completely closed and not just secured in safety position. If it is not perfectly closed, do not try to press the bonnet down but open it and repeat the procedure.

31)



### WARNING

**27)** The bonnet may drop suddenly if the supporting rod is not positioned correctly. Only perform these operations when the car is stationary.

**28)** Be careful working inside engine compartment when the engine is hot to avoid burning yourself. Do not place your hands near the engine fan as it may be activated even when the key is removed. Wait until the engine has cooled.

**29)** Be very careful not to allow scarves, neck ties and other loose articles of clothing from touching, even accidentally, any moving parts. This may cause the clothing to be pulled into the part, resulting in serious risk to the wearer.

**30)** Use both hands to lift the bonnet. Before lifting, check that the windscreen wiper arms are not raised from the windscreen, that the vehicle is stationary and that the handbrake is engaged.

**31)** For safety reasons, the bonnet must always be properly closed while driving. Therefore, always make sure that it is closed properly and that the lock is engaged. If you notice when driving that the bonnet has not been properly locked, stop immediately and close the bonnet correctly.

## BOOT



32) 33)

### OPENING THE TAILGATE WITH THE REMOTE CONTROL

Press button  on the key with the remote control.

The direction indicators will blink twice when the tailgate is opened.

On some versions, opening the tailgate will switch the boot ceiling light on: the light will switch off automatically when the tailgate is closed.



14)



34)

### ELECTRIC HANDLE (SOFT TOUCH)

The tailgate (if unlocked) can be opened from the outside by using the electric opening handle (1) fig. 49

located under the large handle. The activation of the  symbol on the display indicates that the tailgate is not shut properly.



49

AB0A0045C

### CLOSING

To close, lower the tailgate by pressing near the lock until you hear it click.

### EMERGENCY TAILGATE OPENING

To open the tailgate from the passenger compartment if the car battery is flat or the electric tailgate lock is faulty, proceed as follows (see "Extending the boot" in this chapter):

- ☐ extract the rear head restraints
- ☐ fold the backrests over
- ☐ to unlock the tailgate mechanically, working from the inside of the boot, use lever (1) fig. 50.



50

AB0A0047C

## EXTENDING THE LUGGAGE COMPARTMENT

The boot can be partially (50/50) or totally extended by splitting the rear seat.

See the descriptions in "Rear seats" for how to expand the boot.

## REMOVING THE PARCEL SHELF

To remove the parcel shelf, release it from its two side pins and pull it out.



### WARNING

**32)** Never exceed the maximum allowed load in the luggage compartment, see the "Technical specifications" chapter. Also make sure that the objects you place in the boot have been properly secured, to avoid them from being thrown forward consequent to sharp braking and injuring your passengers.



**33)** If you are travelling in areas with few filling stations and you want to transport fuel in a spare tank, comply with the law by using only an approved, suitably secured tank. In the event of a collision the fire risk is increased all the same.

**34)** Do not drive with the tailgate open as exhaust fumes may enter the passenger compartment.



### IMPORTANT

**14)** Be careful not to hit objects on the roof rack when you open the tailgate.

## INTERIOR FITTINGS

### CIGARETTE LIGHTER

(where provided)

It is located on the central tunnel fig. 51, near the handbrake lever. Press button (1) to activate the cigar lighter.



51

AB0A0286C

After a few seconds the button goes back to its initial position and the cigar lighter is ready for use.



**WARNING** Always check that the cigarette lighter is switched off.

**WARNING** Do not connect devices with power higher than 180W to the socket. Do not damage the socket by using unsuitable adaptors.

### SUN VISORS

They are located at the sides of the interior rear-view mirror. They can be adjusted forwards and sideways fig. 52.



52

AB0A0031C

The passenger side sun visor includes a courtesy mirror, lighted by a specific light that can be switched on using the button (1) fig. 52.

The driver and passenger side sun visors include document pockets



### GLOVE COMPARTMENT

(where provided)

It is located on the dashboard, passenger side.

To open the compartment, use handle (1) fig. 53.

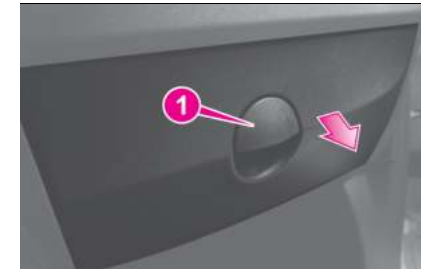

53

AB0A0284C

### STORAGE COMPARTMENT

This is located on the central tunnel (1) fig. 54.

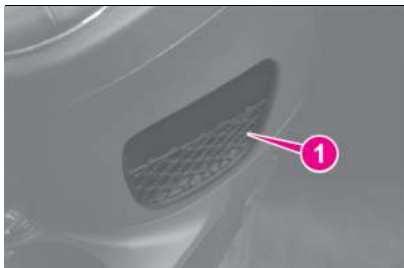

54

AB0A0285C



37)

## CUP/BOTTLE HOLDERS

On the central tunnel there are two cup/can holders for the front seats and two for the rear seats.

## POWER SOCKET

(where provided)

It is located on the central tunnel and is supplied with ignition key at MAR.

Open protective cover to use the socket (1) fig. 55.

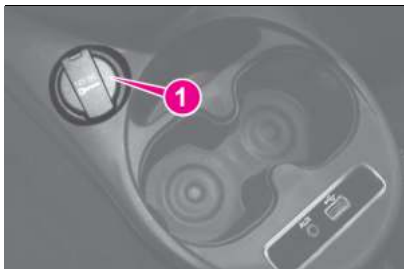

55

AB0A0283C

Correct operation is ensured only if the connected accessories are provided with approved standard plugs, present on all Lineaccessori Abarth components

**WARNING** With the engine off and ignition key turned to MAR, extended use (i.e. for over one hour) of accessories which drain a lot of power may reduce battery efficiency and therefore cause misfiring.



15)

## AUX AND USB PORTS

(where provided)

To connect an external device, use the AUX input fig. 56. To activate USB mode, insert a suitable USB device into the car USB port.



56

AB0A0366C



## WARNING

**35)** *The cigar lighter becomes very hot. Handle it with caution and do not allow it to be used by children to avoid the risk of fire or burns.*

**36)** *On both sides of the passenger side sun visor there is a label remembering that it is compulsory to deactivate the airbags if a rearward facing child restraint system is fitted. Always comply with the instructions on the label (see the "Airbags" paragraph in chapter "Safety").*

**37)** *Do not travel with the storage compartment open: it may injure the front seat occupants in the event of an accident.*



## IMPORTANT

**15)** *Accessories with a maximum power of 180W (maximum electrical input 15 A) can be connected to the socket.*



## ROOF RACK/ SKI RACK

### FASTENERS

The fasteners are located in the area indicated in fig. 57. To use the front fasteners, remove the cap (1) fig. 57, accessible with the door open.



57

AB0A0324C

The rear fixing areas (2) can be found according to measurements shown in fig. 58.

 38) 39) 40)

 16)

Lineaccessori Abarth provides a specific roof rack/ski rack for the tailgate.



58

AB0A0055C

**WARNING** Follow the instructions contained in the assembly kit carefully. Assembly must be performed by qualified personnel.



### WARNING

**38)** Fully comply with the regulations in force concerning maximum clearance. Never exceed the maximum permitted loads; see chapter "Technical specifications".

**39)** Evenly distribute the load and take into account, when driving, the increased responsiveness of the car to side wind. After travelling for a few kilometres, check to ensure that the fixing screws for the attachments are well tightened.

**40)** Before driving, make sure that the transversal bars have been fitted properly.



### IMPORTANT

**16)** The use of transversal bars on longitudinal ones prevents the use of the sunroof, because the latter, while opening, interferes with the bars. Therefore do not move the sunroof if transversal bars have been fitted.

## FIRE EXTINGUISHER

(where provided)

There may be a fire extinguisher (1) fig. 59 in the boot, to be used in the event of fire.

To use the fire extinguisher, loosen the retaining strap and remove it from its case.

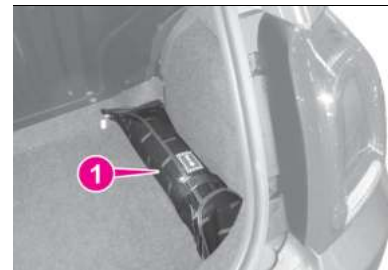

59

AB0A0362C

## AUDIO SYSTEM

The basic audio system is composed of:

- ☐ two mid-woofers, diameter 165 mm, on the front doors;
- ☐ two tweeters, diameter 19 mm, in the front pillars;
- ☐ two full-range speakers, diameter 165 mm, in the rear side panels.

The Hi-Fi audio system is composed of:

- ☐ two mid-woofers, diameter 165 mm, on the front doors;
- ☐ two tweeters, diameter 22 mm, in the front pillars;
- ☐ two full-range speakers, diameter 165 mm, in the rear side panels;
- ☐ one subwoofer, 200 mm;
- ☐ one 8-channel digital amplifier.

Depending on the version, the aerial may be on the roof or on the rear side window.

## PROTECTING THE ENVIRONMENT

The following devices are used for reducing petrol fuel engine emissions:

- ☐ three-way catalytic converter
- ☐ Lambda sensors
- ☐ evaporation control system.



In addition, do not let the engine run, even for a test, with one or more spark plugs disconnected.



### WARNING

**41)** *During normal service the catalyst reaches high temperatures; therefore do not park the car over inflammable materials (grass, dry leaves, pine needles, etc.): fire hazard.*



# KNOWING THE INSTRUMENT PANEL

*This section of the handbook provides all information that is useful for getting to know, interpreting, and using the instrument panel correctly.*

INSTRUMENT PANEL	
FEATURES .....	43
MENU ITEMS .....	46
TRIP COMPUTER .....	52
EOBD SYSTEM .....	53
WARNING LIGHTS AND MESSAGES .....	55

# INSTRUMENT PANEL FEATURES

## COLOUR DISPLAY "STANDARD" SCREEN



60

AB0A0472

1. Odometer (display of distance travelled in kilometres/miles) 2. Digital engine coolant temperature gauge 3. Digital rev counter (tachometer) 4. Range 5. SBR system indications 6. Outside temperature gauge 7. Car speed indication 8. Schedule 9. Current Consumption 10. Digital fuel level gauge 11. Current consumption (numeric)



**SPORT MODE**

If the SPORT mode is active, the longitudinal/lateral accelerometer indicator screen (G-meter information) fig. 61 is displayed automatically.

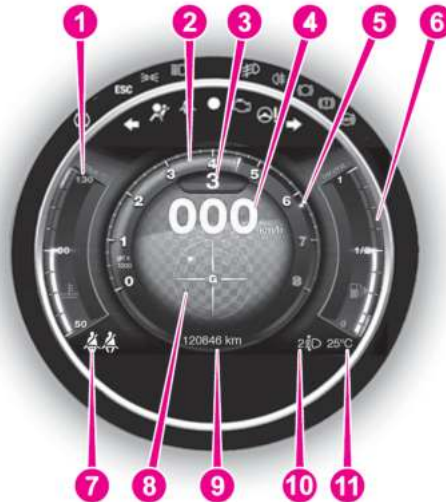

61

AB0A0473

1. Digital engine coolant temperature gauge
2. Digital rev counter (tachometer)
3. Engaged gear indicator
4. Car speed indication
5. Maximum engine rpm reached ("Ghost function")
6. Digital fuel level gauge
7. SBR system indications
8. Longitudinal/lateral instantaneous acceleration
9. Odometer (display of distance travelled in kilometres/miles)
10. Front headlight aiming
11. Outside temperature gauge

## Current Consumption

The indicator (9) fig. 60 allows the driver to monitor the instantaneous fuel consumption in order to drive more efficiently, also from the point of view of harmful emissions.

The instantaneous fuel consumption is shown in l/100 km or mpg (depending on the chosen display).

A more "fluid" drive, will allow the fuel consumption and emissions to be reduced, even though the traffic conditions often will not allow it. A more "aggressive" drive, on the other hand, implies frequent acceleration/deceleration with resulting increased fuel consumption and harmful emissions.

## GEAR SHIFT INDICATOR

The GSI (Gear Shift Indicator) system advises the driver to change gear through a special indication on the display.

Through the GSI, the driver is informed that shifting gear will allow a reduction in fuel consumption.

When the SHIFT (SHIFT UP) icon ▲ is shown on the display, the GSI is advising the driver to engage a higher gear, while the SHIFT (SHIFT DOWN) ▼ icon advises the driver to engage a lower gear.

The indication on the instrument panel remains until the driver shifts gear or the driving conditions return to a situation where gear shifting is not required to improve consumption.

## SPEEDOMETER

Shows the car's speed in km/h or mph depending on the display settings.

## TACHOMETER

This indicates the engine rpm. The indicator (5) fig. 61 activates over 3000 rpm and, for two seconds, shows the maximum engine rpm reached each time the accelerator is pressed and then released ("Ghost function").

## DIGITAL FUEL LEVEL GAUGE

The digital gauge indicates the amount of fuel in the tank.

The  icon appears to indicate that approximately 5 litres of fuel are left in the tank.

Do not travel with the fuel tank almost empty: any gaps in fuel supply could damage the catalytic converter.

## DIGITAL ENGINE COOLANT TEMPERATURE GAUGE

The digital gauge indicates the temperature of the engine coolant and starts giving indications when the coolant temperature exceeds 50°C approx.

The first reference, which is always on, is blue and indicates a low temperature of the engine coolant.

When the temperature increases the reference becomes white and other references come on as well.

If the references become red the temperature of the engine coolant is too high: in this case, see paragraph "Warning lights and messages" in this chapter.

The  icon appears (where present) (on a few versions together with the displayed message) to indicate an excessive temperature increase of the coolant. In this case, stop the engine and contact an Abarth Dealership.

## INSTRUMENT PANEL LIGHTING ADJUSTMENT (Brightness sensor)

Versions with colour display are equipped with a brightness sensor (fitted inside the instrument panel) capable of detecting ambient light conditions and adjusting the brightness of the instrument panel accordingly.

The behaviour of the instrument is as follow:

☐ "daytime" mode: the display can be set to 8 levels;

☐ "night time" mode: the display can be set to 8 levels. The brightness of



the automatic dual zone climate control display is also adjusted.

☐ For adjusting, see the "Menu items" paragraph in this chapter.

### ANALOGUE PRESSURE GAUGE

The car is equipped with a pressure gauge for measuring the turbocharger pressure by means of the analogue indicator (1) fig. 62.

Depending on the model, the indicator (1) scale may reach 2.0 bar.



62

AB0A0333C

**NOTE** The turbocharger supercharging pressure reading on the pressure gauge should never exceed 1 – 1.2 bar even in the case of sporty driving and maximum performance.

### Sport mode display

If the SPORT function is used, the display (2) fig. 62 inside the turbocharger pressure gauge will show the word SPORT.

## MENU ITEMS

The menu comprises a series of options which can be selected using buttons + and – to access the different selection and setting operations (Setup) indicated below. Some options have a submenu.



63

AB0A0002C

+ To scroll up the screen and the respective items or to increase the displayed value.

**MENU** ➡ Press briefly to access the menu and/or go to next screen or to confirm the desired selection. Hold down to go back to the standard screen.

– To scroll through the screen and the options downwards or to decrease the value displayed.

**NOTE** Buttons + and – activate different functions according to the following situations:

☐ within the menu, they allow you to

scroll up or down through the options; ☐ during setting operations, they increase or decrease values.

The menu comprises the following functions:

- ☐ DIMMER
- ☐ SPEED BEEP
- ☐ TRIP B ACTIVATION/DATA
- ☐ SET TIME
- ☐ SET DATE
- ☐ AUTOCLOSE
- ☐ UNITS
- ☐ LANGUAGE
- ☐ BUZZER VOLUME
- ☐ BUTTON VOLUME
- ☐ SEAT BELT BUZZER
- ☐ SERVICE
- ☐ AIRBAG/PASSENGER AIRBAG
- ☐ DAYTIME RUNNING LIGHTS
- ☐ ITPMS RESET
- ☐ SEE RADIO (if present)
- ☐ SEE PHONE (if present)
- ☐ SEE NAVIGATION (if present)
- ☐ EXIT MENU

**NOTE** With the **Uconnect™** system, some Menu items are shown and managed on the display of the latter and not on the instrument panel display (refer to the dedicated Multimedia chapter or to the supplement available online).

*Selecting an item from the main menu without a submenu:*

☐ press the MENU ➡ button briefly to

select the main menu setting you wish to change;

▮ press the **+** or **-** buttons (with single presses) to select the new setting;  
▮ briefly press the MENU button **↵** to store the new setting and to go back to the same main menu option selected previously.

*Selecting an option from the main menu with a submenu:*

▮ briefly press the MENU button **↵** to display the first submenu option;  
▮ press the **+** or **-** buttons (with single presses) to scroll through all the submenu items;  
▮ briefly press the MENU button **↵** to select the displayed submenu option and to open the relevant setup menu;  
▮ press the **+** or **-** buttons (with single presses) to select the new setting for this submenu option;  
▮ a short press on MENU button **↵** will store the setting and then return to the same submenu option that was first selected.

### **Dimmer (Adjust the dashboard and instrument panel lighting)**

On some versions, the instrument panel is provided with a light sensor capable of detecting environmental light conditions and adjusting the

brightness of the instruments accordingly.

The brightness of the instrument panel may therefore change while driving following an event causing a switch from “day” to “night” conditions (or vice versa) in the passenger compartment (e.g. in a tunnel, on avenues in shadows, under flyovers, etc.).

It is possible to manually adjust the instrument panel, control buttons and automatic climate control lighting. The night mode can only be adjusted with the headlights on. If the headlights are not on, it can be adjusted in day mode. Proceed as follows to adjust the light intensity:

▮ press the MENU button **↵** briefly to make the display flash the previously stored level;  
▮ press the **+** or **-** button to adjust the brightness level;  
▮ press the MENU button **↵** briefly to return to the menu screen or hold the button down to return to the standard screen without storing.

On some versions, during the daytime and with dipped headlights on, the instrument panel, control buttons and automatic climate control displays are set to maximum brightness.

### **Speed beep (Speed limit)**

With this function it is possible to set the car speed limit (km/h or mph); when this limit is exceeded the driver is alerted.

To set the desired speed limit, proceed as follows:

▮ briefly press the MENU button **↵**: the display will show the words “Speed Beep”;  
▮ press the **+** or **-** button to select speed limit activation (“On”) or deactivation (“Off”);  
▮ if the function is enabled (On), press the **+** or **-** button to select the required speed limit and press the MENU button **↵** to confirm.



**Note** The speed may be set anywhere between 30 and 200 km/h or 20 and 125 mph, depending on the previously chosen unit, see the “Setting the unit of measurement (Unit)” paragraph. The setting will increase/decrease by 5 units each time button **+** / **-** is pressed. Hold down the **+** / **-** button to automatically increase/decrease the setting rapidly. Complete the adjustment with single presses of the button when you approach the desired value.

Press the MENU button **↵** briefly to return to the menu screen or hold the



button down to return to the standard screen without storing.

To cancel the setting, proceed as follows:



- ▮ press the MENU button  briefly to make the display flash "On";
- ▮ press the  $-$  button, "Off" will flash on the display;
- ▮ press the MENU button  briefly to return to the menu screen or hold the button down to return to the standard screen without storing.

### Trip B activation/data

This function may be used to activate ("On") or deactivate ("Off") the Trip B (partial trip) display.

For further information see the "Trip computer" paragraph in this chapter.





Proceed as follows to switch the function on/off:

- ▮ press the  MENU button briefly, the display will flash "On" or "Off" depending on the previous setting;
- ▮ press  $+$  or  $-$  button to select;
- ▮ press the MENU button  briefly to return to the menu screen or hold the button down to return to the standard screen without storing.

### Set Time (Setting the clock)

Using this function, it is possible to set the clock through two submenus: "Time" and "Format".

To adjust, proceed as follows:

- ▮ briefly press the MENU  button: the display will show the two submenus "Time" and "Format";
- ▮ press the  $+$  or  $-$  button to move between the two submenus;
- ▮ once you have selected a submenu, press the MENU  button briefly;
- ▮ when you select the "Time" submenu, pressing the MENU  button briefly the display shows the "hours";
- ▮ press the  $+$  or  $-$  button to adjust;
- ▮ briefly pressing the MENU  button the "minutes" are displayed;
- ▮ press the  $+$  or  $-$  button to adjust.

**Note** The setting will increase or decrease by one unit each time the  $+$  or  $-$  button is pressed. Hold down the button to increase/decrease the setting rapidly and automatically. Complete the adjustment with single presses of the button when you approach the desired value.



- ▮ When you select the "Format" submenu, pressing the MENU  button briefly the mode is displayed;
- ▮ press  $+$  or  $-$  to select "24h" or "12h". When you have made the adjustment, press SAVE to return to the submenu screen or hold the button down to return to the main menu screen without storing.

▮ hold the MENU button  down again to return to the standard screen or to the main menu according to where you are in the menu.

### Set date (Setting the date)

This function may be used to update the date (year/month/day).

To adjust, proceed as follows:

- ▮ briefly press the MENU  button: "year" will be displayed;
- ▮ press the  $+$  or  $-$  button to adjust;
- ▮ briefly press the MENU  button: "month" is displayed;
- ▮ press the  $+$  or  $-$  button to adjust;
- ▮ briefly press the MENU  button: "day" is displayed;
- ▮ press the  $+$  or  $-$  button to adjust;

**Note** The setting will increase or decrease by one unit each time the  $+$  or  $-$  button is pressed. Hold down the button to increase/decrease the setting rapidly and automatically. Complete the adjustment with single presses of the button when you approach the desired value.





Press SAVE to return to the menu screen or hold the button down to return to the standard screen without storing.

## Autoclose (Automatic central locking with car moving)

(where provided)

When activated (On), this function locks the doors automatically when the vehicle speed exceeds 20 km/h.

Proceed as follows to activate or deactivate this function:





- ▮ press the MENU button  briefly to display a submenu;
- ▮ press the  MENU button briefly, the display will flash "On" or "Off" depending on the previous setting;
- ▮ press + or - button to select;
- ▮ press the  MENU button briefly to return to the submenu screen or hold the button down to return to the main menu screen without saving;
- ▮ hold the MENU button  down again to return to the standard screen or to the main menu according to where you are in the menu.

## Units of measurement (Setting)

This function allows the measurement unit to be set via two submenus: "Distance" and "Fuel Consumption".

To set the desired unit of measurement, proceed as follows:

- ▮ briefly press the MENU button : the display will show the two submenus;



- ▮ press the + or - button to move between the two submenus;
  - ▮ once you have selected a submenu, press the  MENU button briefly;
  - ▮ when you select "Distance", briefly pressing the MENU button  makes the display show "km" or "mi" depending on the previous setting;
  - ▮ press + or - button to select;
  - ▮ when you select "Fuel Consumption", briefly pressing the MENU button  makes km/l, l/100km or mpg appear on the display depending on the previous setting;
- If the set distance unit of measurement is "km", the fuel consumption unit will be displayed in km/l or l/100 km. If the set distance unit is "mi" the fuel consumption unit will be displayed in "mpg".
- ▮ Press the + or - button to select. When you have made the adjustment, press the MENU button  briefly to return to the submenu screen or hold the button down to return to the main menu screen without storing.
  - ▮ Hold the MENU button  down again to return to the standard screen or to the main menu according to where you are in the menu.

## Language (Language selection)

Messages on the display can be shown in the following languages: Italian,

English, German, Portuguese, Spanish, French, Dutch, Polish, Turkish and Russian.



To set the desired language, proceed as follows:

- ▮ briefly press the MENU button : the previously set "language" will flash on the display;
- ▮ press + or - button to select;
- ▮ press the MENU button  briefly to return to the menu screen or hold the button down to return to the standard screen without storing.

## Warnings volume (Adjusting the failure/warning acoustic signal volume)

This function allows the volume of the buzzer which accompanies the display of failures / warnings to be adjusted to 8 levels.

To set the desired volume, proceed as follows:

- ▮ briefly press the MENU button : the previously set volume level will flash on the display;
- ▮ press the + or - button to adjust;
- ▮ press the MENU button  briefly to return to the menu screen or hold the button down to return to the standard screen without storing.



### Button volume (Adjustment)

This function may be used to adjust (to 8 levels) the volume of the acoustic signal made when the **↵** MENU, **+** and **-** buttons are pressed.

To set the desired volume, proceed as follows:

- ▮ briefly press the MENU button **↵**: the previously set volume level will flash on the display;
- ▮ press the **+** or **-** button to adjust;
- ▮ press the MENU button **↵** briefly to return to the menu screen or hold the button down to return to the standard screen without storing.

### Seat belt buzzer (Reactivation of buzzer for SBR signal)

This function can be only displayed after an Abarth Dealership has deactivated the SBR system (see paragraph "SBR system" in the "Safety devices" chapter).

To reactivate this function, proceed as follows:

- ▮ press the **↵** MENU button briefly and the display will flash "Off". Press the **+** or **-** button to display "On";
- ▮ press the **↵** MENU button briefly to return to the submenu screen or hold the button down to return to the main menu screen without saving.

### Service (scheduled servicing)

Using this function you can display information about the mileage intervals for vehicle servicing.

To consult this information, proceed as follows:

- ▮ press the **↵** button: the display shows when servicing is due in km/mi or days (where provided) according to the previous setting (see paragraph "Units of measurement");
- ▮ press the **↵** button to return to the menu screen; press the button again to return to the standard screen.

WARNING The "Service Schedule" includes vehicle maintenance at fixed intervals (refer to the "Maintenance and care" chapter).

This is displayed automatically, with ignition key at MAR-ON, 2000 km (or equivalent value in miles) before servicing or, where present, 30 days before servicing. It is also displayed each time the key is turned to MAR-ON or, where present, every 200 km (or equivalent value in miles). Below this threshold servicing indications are more frequent.

The display will be in km or miles according to the unit of measurement set. When the following scheduled

service deadline is approaching, the word "Service" will appear on the display, followed by the number of kilometres/miles or days (where present) left, when the ignition key is turned to MAR. Go to an Abarth Dealership, where the "Service Schedule" operations will be performed and the message will be reset.

When the service interval is reached and for about 1000 km/600 mi or 30 days, a service due message is displayed.

### Airbag/Passenger airbag (front passenger side airbag and side bag for pelvis, chest and shoulder protection - Side bag - activation/deactivation)

This function is used to activate/deactivate the front passenger's airbag. Proceed as follows:

- ▮ press the MENU **↵** button and, after the display shows the message "Bag pass: Off" (to deactivate) or the message "Bag pass: On" (to activate) through the pressing of the **+** and **-** buttons, press the MENU **↵** button again;
- ▮ a confirmation request message will appear on the display;

press the + or - buttons to select "Yes" (to confirm enable/disable) or "No" (to abort);

press the MENU button  briefly, a message confirming the selection will be displayed and you will return to the menu screen or hold the button down to return to the standard screen without storing.

### Passenger protection off:

instrument panel LED  on fixed.

### Daytime running lights (DRL)

(where provided)

With this function is possible to turn the daytime running lights on and off.

Proceed as follows to activate or deactivate this function:

press the MENU button  briefly to display a submenu;

press the  MENU button briefly, the display will flash "On" or "Off" depending on the previous setting;

press + or - button to select;

press the  MENU button briefly to return to the submenu screen or hold the button down to return to the main menu screen without saving;

hold the MENU button  down again to return to the standard screen or to the main menu according to where you are in the menu.

### Reset tyres (iTPMS reset)

(where provided)

With this function it is possible to reset the iTPMS (see paragraph "iTPMS").

To carry out the Reset procedure proceed as follows:

briefly press the MENU  button: the display will show Reset;

press the + or - button to select ("Yes" or "No");

briefly press the MENU  button: the display will show "Confirm";

press the + or - button to select ("Yes" to reset or "No" to exit the video page);

briefly press the MENU  button to confirm the selection ("Yes"/"No"). If you answer Yes, the reset is confirmed.

hold the MENU button  down again to return to the standard screen or to the main menu according to where you are in the menu.

### Radio repetition (audio information repetition)

(where provided)

This Menu item allows some information displayed on **Uconnect™** system to be repeated on the instrument panel display.

To show the **Uconnect™** information on the display ("On"), or clear it ("Off"),

proceed as follows:

press the  MENU button briefly, the display will flash "On" or "Off" depending on the previous setting;

press + or - button to select;

press the MENU button  briefly to return to the menu screen or hold the button down to return to the standard screen without storing.

### See phone

(where provided)

This Menu item allows some information displayed on **Uconnect™** system to be repeated on the instrument panel display.

To show the **Uconnect™** information on the display ("On"), or clear it ("Off"), proceed as follows:

press the  MENU button briefly, the display will flash "On" or "Off" depending on the previous setting;

press + or - button to select;

press the MENU button  briefly to return to the menu screen or hold the button down to return to the standard screen without storing.

### See navigation

(where provided)

This Menu item allows some information displayed on **Uconnect™** system to be repeated on the instrument panel display.



To show the **Uconnect™** information on the display ("On"), or clear it ("Off"), proceed as follows:

- ☐ press the **MENU** button briefly, the display will flash "On" or "Off" depending on the previous setting;
- ☐ press **+** or **-** button to select;
- ☐ press the **MENU** button **MENU** briefly to return to the menu screen or hold the button down to return to the standard screen without storing.

### Exit Menu

This is the last function that closes the cycle of settings listed in the menu screen.

Pressing the **MENU** button **MENU** briefly will return the display to the standard screen without storing.

Press the **-** button to go back to the first menu option ("Speed Buzzer").

## TRIP COMPUTER

The Trip computer is used to display information on car operation when the ignition key is turned to MAR.

This function is characterised by two separate memories, called "Trip A" and "Trip B", where the car's "complete missions" (journeys) are recorded in a reciprocally independent manner, as well as, for versions where present, "Instant info" and "Best average consumption".

Both memories can be reset: i.e. start of a new journey.

"Trip A" can be used to display the values relating to:

- ☐ Range (where present)
- ☐ Distance travelled A
- ☐ Average consumption A
- ☐ Instantaneous fuel consumption (where present)
- ☐ Average speed A
- ☐ Travel time A (driving time)
- ☐ Reset Trip A.

"Best average consumption": in ECO mode, displays a screen summarising the best average consumption (where provided). The icon  indicates the best performance.

This information can be reset by resetting Trip A.

"Trip B" may be used to display the figures relating to:

- ☐ Distance travelled B
- ☐ Average consumption B
- ☐ Average speed B
- ☐ Travel time B (driving time)
- ☐ Reset Trip B.

The "Trip B" function can be disabled (see the "Menu items" paragraph).

"Range" and "Instant consumption" values cannot be reset. "Instantaneous info" displays the following values (where present, when they are not displayed in the main screen):

- ☐ Range
- ☐ Instant consumption

### VALUES DISPLAYED

#### Range (where present)

This indicates the distance that can still be travelled with the fuel in the tank, assuming that driving style remains unvaried. The display will show the reading "- - -" when the following events take place:

- ☐ range is lower than 50 km (or 30 mi)
- ☐ car parked with engine running for a long period.

**WARNING** The range can be affected by several factors: driving style (see "Driving style" paragraph in the "Starting and driving" chapter), type of route (motorway, towns and cities,

mountain roads, etc.), conditions of use (load, tyre pressures, etc.). Trip planning must therefore take the above into account.

### **Distance travelled**

This value shows the distance travelled from the start of the new journey.

### **Average fuel consumption**

This value shows the approximate average fuel consumption from the start of the new journey.

### **Instantaneous fuel consumption (where present)**

This value shows the fuel consumption. The value is constantly updated. The display will show "- - - -" if the car is parked with the engine running.

### **Average speed**

This value shows the car's average speed based on the overall time elapsed since the start of the new journey.

### **Travel time**

Time elapsed since the start of the new journey.

## **TRIP BUTTON**

The TRIP button is located on the right-hand stalk fig. 64. With the ignition key turned to MAR, this button allows you to view the previously described values

and also zero them to begin a new mission:

- ▮ *brief press* to access the various parameter displays;
- ▮ *long press* to reset and then start a new mission.



64

AB0A0140C

### **New mission**

This begins after a reset:

- ▮ "manual" resetting by the user, by pressing the relevant button;
- ▮ "automatic" resetting, when the "trip distance" reaches 99999.9 km or when the "trip time" reaches 999:59 (999 hours and 59 minutes);
- ▮ after disconnection/reconnection of the battery.

**WARNING** The reset operation when "Trip A" or "Trip B" details are being displayed resets the information associated with the function displayed.

## **Start of journey procedure**

With the ignition key in the MAR-ON position, reset by pressing the TRIP button and keeping it pressed for more than 2 seconds.

### **Exit Trip**

You can automatically exit the TRIP function once all the values have been displayed or by holding the MENU button  down for more than 1 second.

## **EOBD SYSTEM**

The EOBD system (European On Board Diagnosis) carries out a continuous diagnosis of the components of the car related to emissions. It also alerts the driver, by turning on the warning light  on the instrument panel together with relevant message on the display, when these components are no longer in peak conditions (see chapter "Warning lights and messages").

The goal of the system is to:

- ▮ monitor system efficiency;
- ▮ indicate an increase in emissions due to vehicle malfunction;
- ▮ indicate the need to replace damaged components.

The system also has a connector that can be interfaced with appropriate equipment, which makes it possible to read the error codes stored in the control unit together with a series



of specific parameters for engine operation and diagnosis.

WARNING After eliminating the failure, to check the system completely, Abarth Dealerships must run a bench test and, if necessary, road tests which may also call for a long journey.

## WARNING LIGHTS AND MESSAGES







**WARNING** The warning light switches on together with a dedicated message and/or acoustic signal when applicable. These indications are indicative and precautionary and as such must not be considered as exhaustive and/or alternative to the information contained in the Owner Handbook, which you are advised to read carefully in all cases. In the event of a failure indication, always refer to the contents of this chapter.

**WARNING** The failure indicators appearing on the display are divided into two categories: very serious and less serious failures. Serious faults are indicated by a repeated and prolonged warning "cycle". Less serious faults are indicated by a warning "cycle" with a shorter duration. The display cycle of both categories can be interrupted. The instrument panel warning light will stay on until the cause of the malfunction is eliminated.



### WARNING LIGHTS ON INSTRUMENT PANEL

Warning light	What it means
 red	<b>SEAT BELTS REMINDER</b> The warning light switches on constantly with the vehicle stationary and the driver's side or passenger side seat belt (when the passenger is present) not fastened. The warning light will flash and a buzzer will sound if the car is in motion and the front seat belts are not correctly fastened. For permanent deactivation of the acoustic signal (buzzer) of the S.B.R. (Seat Belt Reminder) system contact an Abarth Dealership. The system can be reactivated at any time using the Setup Menu.









Warning light	What it means
 <p>red</p>  <p>amber</p>  <p>amber</p>	<p><b>EBD FAILURE</b></p> <p>The simultaneous switching on of the warning lights with the engine on indicates either an anomaly of the EBD system or that the system is not available. In this case, the rear wheels may suddenly lock and the car may swerve when braking sharply. On some versions the display shows the dedicated message. Drive very carefully to an Abarth Dealership to have the system inspected immediately.</p>
 <p>red</p>	<p><b>AIR BAG FAILURE</b></p> <p>The warning light switches on when the ignition key is turned to MAR, but it should switch off after a few seconds.</p> <p>The warning light stays on constantly if there is a fault in the airbag system. On some versions the display shows the dedicated message.</p> <p> 42) 43)</p>
 <p>red</p>	<p><b>LOW BRAKE FLUID/HANDBRAKE ENGAGED</b></p> <p>The warning light switches on when the ignition key is turned to MAR, but it should switch off after a few seconds.</p> <hr/> <p><b>Low brake fluid level</b></p> <p>The warning light turns on when the level of the brake fluid in the reservoir falls below the minimum level, possibly due to a leak in the circuit. On some versions the display shows the dedicated message.</p> <p> 44)</p> <hr/> <p><b>Handbrake engaged</b></p> <p>The warning light switches on when the handbrake is engaged.</p> <p>On certain versions, if the car is moving the acoustic warning will also sound.</p> <p><b>IMPORTANT</b> If the warning light turns on while driving, check that the handbrake is not engaged.</p>



Warning light	What it means
 <p data-bbox="181 353 217 370">red</p>	<p data-bbox="344 115 858 135"><b>“DUALDRIVE” ELECTRIC POWER STEERING FAILURE</b></p> <p data-bbox="344 140 1390 236">When the key is turned to MAR, the warning light switches on but it should switch off after a few seconds. If the warning light stays on, on some versions along with a dedicated message on the display, you may not have steering assistance and the effort required to operate the steering wheel could be notably increased; steering is, however, possible.</p> <p data-bbox="344 240 735 260">In this case, contact an Abarth Dealership.</p> <p data-bbox="344 265 1390 339">If the warning light switches on while driving (on some versions, together with a dedicated message on the display) you may not have steering assistance. Although it will still be possible to steer the car, the effort needed to operate the steering wheel could be increased: contact an Abarth Dealership as soon as possible.</p> <p data-bbox="344 343 1390 440"><b>IMPORTANT</b> In some circumstances, factors independent of the electric power steering could cause the warning light on the instrument panel to switch on. In this case, stop the car immediately (should it be in motion), stop the engine for about 20 seconds and then restart the engine. If the warning light stays on, contact an Abarth Dealership.</p> <p data-bbox="344 444 1390 518"><b>IMPORTANT</b> After the battery is disconnected, the steering must be initialised. The warning light switches on to indicate this. To carry out this procedure, simply turn the steering wheel all the way from one end to the other or drive in a straight line for about a hundred metres.</p>

Warning light	What it means
 <p data-bbox="169 717 229 734">amber</p>	<p data-bbox="344 641 528 661"><b>BRAKE PAD WEAR</b></p> <p data-bbox="344 666 1390 717">The warning light switches on, together with a dedicated message on the display on some versions, if the front or rear brake pads (where provided) are worn. In this case have them replaced as soon as possible.</p>
 <p data-bbox="169 939 229 956">amber</p>	<p data-bbox="344 764 475 785"><b>ESC SYSTEM</b></p> <p data-bbox="344 789 1310 836">The warning light switches on when the ignition key is turned to MAR, but it should switch off after a few seconds.</p> <hr/> <p data-bbox="344 863 576 883"><b>ESC system activation</b></p> <p data-bbox="344 888 1142 908">Flashing of the warning light while driving indicates the intervention of the ESC system.</p> <hr/> <p data-bbox="344 935 539 955"><b>ESC system failure</b></p> <p data-bbox="344 959 1390 1033">If the warning light does not go off or stays on together with the LED on the TTC button while driving. The display will show a dedicated message. Contact an Abarth Dealership.</p>





Warning light	What it means
 <p data-bbox="272 202 338 221">amber</p>	<p data-bbox="448 118 632 137"><b>Hill Holder failure</b></p> <p data-bbox="448 146 1497 191">This warning light switches on, on some versions together with a dedicated message on the display, in the event of a Hill Holder system failure.</p> <p data-bbox="448 197 1035 216">In this case, contact an Abarth Dealership as soon as possible.</p>
 <p data-bbox="272 479 338 498">amber</p>	<p data-bbox="448 249 815 268"><b>INJECTION / EOBD SYSTEM FAILURE</b></p> <p data-bbox="448 274 1481 319">Under normal conditions, the warning light comes on when the ignition key is turned to MAR, but should go off as soon as the engine is started.</p> <p data-bbox="448 324 1490 423">The warning light remains on or switches on while driving, on some versions together with a dedicated message on the display, if the injection system is not working properly. In particular, if the warning light switches on continuously, it indicates a malfunction in the supply/ignition system that could cause excessive exhaust emissions, a possible loss of performance, poor driveability and high fuel consumption.</p> <p data-bbox="448 428 1497 499">Under these conditions, the vehicle can continue travelling at moderate speed without demanding excessive effort from the engine. Prolonged use of the car with the warning light on may cause damage. Contact an Abarth Dealership as soon as possible.</p> <p data-bbox="448 505 1469 603">If the warning light is flashing, this indicates that the catalytic converter may be damaged. If the light flashes, release the accelerator pedal to reduce engine revs until the warning light stops flashing; continue the journey at a moderate speed, trying to avoid driving conditions that may cause further flashing, and contact an Abarth Dealership as soon as possible.</p> <p data-bbox="448 609 499 628"> 45)</p>
 <p data-bbox="272 753 338 772">amber</p>	<p data-bbox="448 689 624 708"><b>REAR FOG LIGHT</b></p> <p data-bbox="448 714 1058 733">The warning light switches on when the rear fog light is activated.</p>
 <p data-bbox="272 941 338 960">amber</p>	<p data-bbox="448 798 584 817"><b>ABS FAILURE</b></p> <p data-bbox="448 823 1422 868">The warning light switches on when the ignition key is turned to MAR, but it should switch off after a few seconds.</p> <p data-bbox="448 873 1437 944">The warning light comes on, on some versions along with a message on the display, when the system is inefficient or not available. In this case the braking system maintains its efficiency unaltered but without the advantage of the ABS system.</p> <p data-bbox="448 949 1094 968">Drive carefully and contact an Abarth Dealership as soon as possible.</p> <p data-bbox="448 974 499 993"> 46)</p>

Warning light	What it means
 <p data-bbox="169 374 229 394">amber</p>	<p data-bbox="344 114 497 159">iTPMS (where provided)</p> <p data-bbox="344 165 529 185"><b>Tyre pressure low</b></p> <p data-bbox="344 192 1390 315">The warning light switches to indicate that the pressure of one or more tyres is lower than the recommended value, in order to guarantee long tyre life and low fuel consumption, or to indicate a slow loss of pressure. In this way the iTPMS warns the driver that one or more tyres may be flat and probably punctured. In this case it is advisable to restore the correct pressure value. Once the normal operating conditions of the car are restored, carry out the Tyre reset procedure.</p> <p data-bbox="344 322 443 342">WARNING</p> <p data-bbox="344 349 1390 394">Do not continue driving with one or more flat tyres as handling may be compromised. Stop the vehicle, avoiding sharp braking and steering.</p> <hr/> <p data-bbox="344 421 804 441"><b>iTPMS failure/iTPMS temporarily deactivated</b></p> <p data-bbox="344 448 1390 544">The warning light flashes for about 75 seconds and then stays on constantly (along with a dedicated message on the display) to indicate that the system is temporarily deactivated or faulty. The system goes back to normal operation when the operating conditions allow it. If this is not the case, carry out the Tyre reset procedure after restoring the normal operating conditions.</p> <p data-bbox="344 551 1139 571">If the malfunction warning persists, contact an Abarth Dealership as soon as possible.</p>

Warning light	What it means
 <p data-bbox="169 792 229 813">green</p>	<p data-bbox="344 672 995 692">SIDE LIGHTS AND DIPPED BEAM HEADLIGHTS/FOLLOW ME HOME</p> <p data-bbox="344 698 750 719"><b>Side lights and dipped beam headlights</b></p> <p data-bbox="344 725 1145 745">The warning light switches on when the side lights or dipped headlights are turned on.</p> <hr/> <p data-bbox="344 772 517 792"><b>Follow Me Home</b></p> <p data-bbox="344 799 1390 844">The warning light comes on, on some versions along with a dedicated message on the display, when the "Follow me home" device is used.</p>
 <p data-bbox="169 960 229 981">green</p>	<p data-bbox="344 902 469 922">FOG LIGHTS</p> <p data-bbox="344 929 970 949">The warning light comes on when the front fog lights are turned on.</p>









Warning light	What it means
 green	<b>LEFT DIRECTION INDICATOR</b> The warning light turns on when the direction indicator control lever is moved downwards or, together with the right indicator, when the hazard warning light button is pressed.
 green	<b>RIGHT DIRECTION INDICATOR</b> The warning light turns on when the direction indicator control lever is moved upwards or, together with the left indicator, when the hazard warning light button is pressed.



Warning light	What it means
 blue	<b>MAIN BEAM HEADLIGHTS</b> The warning light switches on when the main beam headlights are turned on.





### INSTRUMENT PANEL WARNING SYMBOLS





Symbol	What it means
 red red red	<b>DOORS/BONNET/BOOT OPEN</b> The symbols on the display switches on, together with a dedicated message, on some versions, when one or more doors, the tailgate or the bonnet (where provided) are not properly closed. An acoustic warning is also emitted with the doors open and the car in motion.

Symbol	What it means
 red	<p>LOW BATTERY CHARGE</p> <p>If the warning light or the symbol on the display (together with a dedicated message on the display on some versions) remains on, contact an Abarth Dealership immediately.</p>
 red	<p>INSUFFICIENT ENGINE OIL PRESSURE/ENGINE OIL DETERIORATED</p> <p>When the key is turned to MAR the icon appears (where present), but should disappear as soon as the engine is started.</p> <p>NOTE Where present, the warning light may be amber</p> <hr/> <p><b>Low engine oil pressure</b></p> <p>The symbol appears continuously together with the message on the display (where present) when the system detects that the engine oil pressure is insufficient.</p> <p> 47)</p>
 red	<p>ENGINE COOLANT TEMPERATURE TOO HIGH</p> <p>On some versions, the symbol appears on the display when the engine is overheated together with a dedicated message on the display.</p> <p><b>In normal driving conditions:</b> stop the car, switch off the engine and check that the fluid level in the reservoir is not below the MIN mark. In this case, wait for the engine to cool down, then slowly and carefully open the cap, top up with coolant and check that the level is between the MIN and MAX marks on the reservoir itself. Also check visually for any fluid leaks. Contact an Abarth Dealership if the warning light switches on when the engine is started again;</p> <p><b>If the car is used under demanding conditions</b> (e.g. when fully loaded): slow down and, if the warning light stays on, stop the car. Stop for two or three minutes with the engine running and slightly accelerated to facilitate better coolant circulation, then turn the engine off. Check that the coolant level is correct as described above. IMPORTANT Over demanding routes, it is advisable to keep the engine running and slightly accelerated for a few minutes before turning it off</p>
 red	<p>ROBOTISED SEQUENTIAL GEARBOX FAILURE</p> <p>When the ignition key is turned to MAR, the icon appears but should disappear after a few seconds. The icon flashes, along with a dedicated message on the display and an acoustic warning, to indicate transmission failure.</p> <p> 17)</p>











Symbol	What it means
 red	<b>Airbag warning light failure</b> (where present) The icon lights up when an anomaly is detected in the warning light  .
 red	<b>SPEED LIMIT EXCEEDED</b> The symbol is shown on the display, together with a dedicated message and an acoustic signal, when the vehicle exceeds the speed limit set in the Setup Menu (e.g. 120 km/h). For some markets, the symbol is red.

Symbol	What it means
 amber	<b>POSSIBLE ICE ON ROAD</b> The symbol is displayed when the outside temperature falls to or below 3°C. On some versions the display shows the dedicated message.
 amber	<b>PARKING SENSOR FAILURE</b> (where provided) The symbol is shown on the display together with a dedicated message if there is a fault in the parking sensors.
 amber	<b>SERVICE (SCHEDULED SERVICING) EXPIRED</b> When the scheduled servicing is nearly due ("scheduled service deadline"), the display will show the symbol followed by the number of kilometres/miles until the car must be serviced. This is displayed automatically, with ignition key at MAR, 2000 km (or equivalent value in miles) before servicing or, for some markets, 30 days before servicing. It is also displayed each time the key is turned to MAR or, for some markets, every 200 km (or equivalent value in miles). Go to an Abarth Dealership, where the "Service Schedule" operations will be performed and the message will be reset.
 amber	<b>ASR SYSTEM</b> On some versions, the display will show the symbol together with a dedicated message on the display, when the ASR system is deactivated.









Symbol	What it means
 amber	<p>HILL HOLDER FAILURE (where provided)</p> <p>The display will show the symbol together with a dedicated message on some versions when there is an anomaly in the Hill Holder system. In this case, contact an Abarth Dealership as soon as possible.</p>
 amber	<p>FUEL CUT-OFF SYSTEM</p> <p>The display will show the symbol and a dedicated message if the fuel cut-off system intervenes. For the fuel cut-off system re-activation procedure, see the "Fuel cut-off system" paragraph, in the "In an emergency" chapter.</p>
 amber	<p>FUEL CUT-OFF SYSTEM FAILURE</p> <p>The display will show the symbol and a dedicated message if the fuel cut-off system is faulty.</p>
 amber	<p>EXTERIOR LIGHTS FAILURE (where provided)</p> <p>The symbol is shown on the display together with a dedicated message when there is an anomaly in one of the following lights:</p> <ul style="list-style-type: none"> <li>☐ daytime running lights (DRL)</li> <li>☐ side lights</li> <li>☐ direction indicators</li> <li>☐ rear fog light</li> <li>☐ number plate lights</li> </ul> <p>The anomaly relating to these lights could be: one or more blown bulbs, a blown protection fuse or a break in the relevant electric connection.</p>
 amber	<p>BRAKE LIGHT FAILURE (where provided)</p> <p>The display will show the symbol together with a dedicated message if there is a fault in the brake lights. The fault may be caused by a blown bulb, a blown protection fuse or a break in the relevant electrical connection.</p>



Symbol	What it means
 <p>amber</p>	<p><b>FIAT CODE SYSTEM FAILURE</b>            With the ignition key in the MAR position, on some versions the warning light, or the symbol on the display, turns on continuously, along with a dedicated message on the display, to signal a possible Fiat CODE system failure. If the symbol appears on the display with engine running, it means that the vehicle is not protected by the engine immobiliser device.            In this case, contact an Abarth Dealership as soon as possible.</p>
 <p>amber</p>	<p><b>FUEL RESERVE - LIMITED RANGE</b>            When the key is turned to MAR, the icon appears but should disappear after a few seconds. The symbol switches on in the display when about 5 litres of fuel are left in the tank. The triangle to the side of the symbol indicates the side of the car with the fuel filler.</p>
 <p>amber</p>	<p><b>ENGINE OIL PRESSURE SENSOR FAILURE INDICATOR</b>            The icon appears when a fault is detected in the engine oil pressure sensor. Contact an Abarth Dealership as soon as possible to have the fault fixed.</p>
 <p>amber</p>	<p><b>OIL CHANGE</b>            The icon indicates that it is necessary to change the engine oil. Contact an Abarth Dealership.</p>
 <p>amber</p>	<p><b>PRESS THE CLUTCH PEDAL TO START</b>            This symbol turns on to indicate that the clutch pedal must be pressed to enable starting.</p>
 <p>amber</p>	<p><b>FUEL LEVEL SENSOR FAILURE</b>            The symbol switches on in the event of fuel level sensor failure. Contact an Abarth Dealership.</p>
 <p>amber</p>	<p><b>RAIN SENSOR FAILURE</b>            The symbol switches on in the case of failure of the rain sensor. Contact an Abarth Dealership as soon as possible.</p>
 <p>AUTO amber</p>	<p><b>DUSK SENSOR FAILURE</b>            The symbol switches on along with a message on the display in the event of dusk sensor failure. Contact an Abarth Dealership as soon as possible.</p>

Symbol	What it means
 white	<b>HEADLIGHT ALIGNMENT CORRECTOR</b> The icon, together with a number, indicates the depth of the dipped beam.

 **WARNING**

- 42)** If when turning the key to MAR the warning light  does not turn on or stays on whilst driving, a failure may have occurred in the restraint systems. In this case the airbags or pretensioners may not be deployed in an impact or, in a lower number of cases, they may be deployed accidentally. Before driving off, contact an Abarth Dealership to have the system checked immediately.
- 43)** A failure of the  warning light is indicated by the  symbol on the display. In this case, the  warning light may not indicate a possible problem with the airbag restraint system. Before driving off, contact an Abarth Dealership to have the system checked immediately.
- 44)** If the  warning light turns on when travelling (on certain versions together with the message on the display) stop the vehicle immediately and contact an Abarth Dealership.
- 45)** Go to an Abarth Dealership as soon as possible if warning light  either does not light up when the key is turned to MAR to if while travelling the warning lights comes on either steady or blinking (along with a message on the display). The operation of the  warning light may be checked by the traffic police using specific devices. Comply with the laws and regulations of the country where you are driving.
- 46)** If the warning light flashes or the symbol is constantly on, depending on the versions, there is an anomaly in the system. If this is the case, go to an Abarth Dealership to have the system checked.
- 47)** If the  warning light switches on while driving (on certain versions together with a dedicated message on the display) stop the engine immediately and contact an Abarth Dealership.

 **IMPORTANT**

- 17)** If there is a failure in the transmission, contact an Abarth Dealership as soon as possible to check the system.

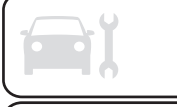

*The chapter that you are about to read is very important: it describes the safety systems with which the car is equipped and provides instructions on how to use them correctly.*

# **SAFETY**

ACTIVE SAFETY SYSTEMS .....	67
iTPMS (indirect Tyre Pressure Monitoring System).....	70
OCCUPANT PROTECTION SYSTEMS .....	72
SEAT BELTS .....	72
SBR SYSTEM (Seat Belt Reminder) .....	73
PRE-TENSIONERS.....	74
CHILD RESTRAINT SYSTEMS .....	76
SUPPLEMENTARY RESTRAINT SYSTEM (SRS) – AIRBAG .....	86

## ACTIVE SAFETY SYSTEMS

The vehicle has the following active safety systems:

- ☐ ABS (Anti-lock Braking System);
- ☐ EBD (Electronic Brake force Distribution);
- ☐ DTC (Drag Torque Control);
- ☐ ESC (Electronic Stability Control);
- ☐ HH (Hill Holder);
- ☐ ASR (Antislip Regulation);
- ☐ PBA (Panic Brake Assist);
- ☐ TTC (Torque Transfer Control)

For the operation of the systems, see the following description.

### ABS (Anti-lock Braking System)

This system, which is an integral part of the braking system, prevents one or more wheels from locking and slipping in any road surface condition, irrespective of the intensity of the braking action, ensuring that the car can be controlled even during emergency braking thus optimising stopping distances.

The system intervenes during braking when the wheels are about to lock, typically in emergency braking or low-grip conditions, when locking may be more frequent.

The system also improves control and stability of the car when braking on a

surface where the grip of the left and right wheels varies, or on corners.

The Electronic Braking Force Distribution (EBD) system completes the system allowing the brake force to be distributed between the front and rear wheels.

### System intervention

A slight pulsing of the brake pedal and noise indicates the intervention of the ABS: this is completely normal when the system intervenes.

 48) 49) 50) 51) 52) 53) 54) 55) 56)

### DTC (Drag Torque Control) SYSTEM

The system prevents the drive wheels from possibly locking, which could happen, for example, if the accelerator pedal is released suddenly or in the case of a sudden downshifting in conditions of poor grip. In these conditions, the engine braking effect could cause the drive wheels to slip, resulting in a loss of car stability. In these situations, the DTC system intervenes, restoring torque to the engine in order to conserve vehicle stability and increase vehicle safety.

### ESC (Electronic Stability Control) SYSTEM

The ESC system improves the directional control and stability of the car in various driving conditions.

The ESC system corrects the car's understeer and oversteer, distributing the brake force on the wheels appropriately. The torque supplied by the engine can also be reduced in order to maintain control of the vehicle. The ESC system uses sensors installed on the car to determine the trajectory that the driver intends to follow and compares it with the car's effective trajectory. When the real trajectory deviates from the desired trajectory, the ESC system intervenes to counter the vehicle's understeer or oversteer.

**Oversteer:** occurs when the car is turning more than it should with respect to the angle of the steering wheel.

**Understeer:** occurs when the car is turning less than it should with respect to the angle of the steering wheel.

### System intervention

The system intervention is signalled by the blinking of the instrument panel warning light **ESC**, to inform the driver that the car is in critical stability and grip conditions.

 57) 58) 59) 60) 61) 62)

### HH (Hill Holder) SYSTEM

This is an integral part of the ESC system and facilitates starting on slopes, activating automatically in the following cases:



▮ uphill: car stationary on a road with a gradient higher than 5%, engine running, brake pressed and gearbox in neutral or gear (other than reverse) engaged;

▮ downhill: car stationary on a road with a gradient higher than 5%, engine running, brake pressed and reverse gear engaged.

When setting off, the ESC system control unit maintains the braking pressure on the wheels until the engine torque required for starting is reached, or in any case for a maximum of 2 seconds, allowing you to move your right foot easily from the brake pedal to the accelerator.

When the 2 seconds have elapsed, without starting, the system is automatically deactivated, gradually releasing the braking pressure.

During this release stage, the typical mechanical brake release noise can be heard, indicating that the car is about to move.



63) 64)

### **ASR (AntiSlip Regulation) SYSTEM**

This is an integral part of the ESC system and automatically operates in the event of one or both drive wheels slipping, loss of grip on wet roads (aquaplaning) and acceleration on slippery, snowy or icy roads, etc.

Depending on the slipping conditions, two different control systems are activated:

▮ if the slipping involves both drive wheels, the ASR system intervenes, reducing the power transmitted by the engine;

▮ if the slipping only involves one of the drive wheels, it also intervenes automatically, braking the wheel that is slipping.

### **System intervention**

This is indicated by the  icon appearing on the instrument panel, to inform the driver that the car is in critical stability and grip conditions.

### **Manual engagement/release**

The ASR is switched on automatically each time the engine is started. While driving, the ASR can be switched off and subsequently switched on again by pressing the button (1) fig. 65 (TTC). When the system is not active, the LED on the same button turns on and, on some versions, a message appears on the display. If the ASR is turned off while driving, this is automatically reactivated at the following car starting. When travelling on snowy roads with snow chains, it may be helpful to turn the ASR off: in fact, in these conditions, the driving wheels skidding when moving off gives you better traction.

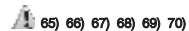

65) 66) 67) 68) 69) 70)

### **PBA (Panic Brake Assist) SYSTEM**

The PBA system is designed to improve the vehicle's braking capacity during emergency braking.

The system detects an emergency braking by monitoring the speed and strength with which the brake pedal is pressed, thereby applying the optimal brake pressure. This can reduce the braking distance: the PBA system therefore completes the ABS.

Maximum assistance of the PBA system is obtained pressing the brake pedal very quickly; in addition, the brake pedal should be pressed continuously during braking, avoiding intermittent presses, to obtain benefits from the system.

Do not reduce pressure on the brake pedal until braking is no longer necessary.

The PBA system is deactivated when the brake pedal is released.

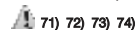

71) 72) 73) 74)

### **TTC (Torque Transfer Control) SYSTEM**

It is an integral part of the ESC system. This system improves the transfer of engine torque to the wheels, guaranteeing safer and more sporty

driving, especially when cornering, far more able to prevent understeer.

### Switching the system on

The system is activated by pressing the button (1) fig. 65 in the dashboard. Activation is signalled by the LED in the TTC button lighting up.



65

AB0A0226C



**48)** When the ABS intervenes and you feel the brake pedal pulsating, do not reduce the pressure, but hold it down firmly and confidently; in doing so you will brake in the shortest distance possible, depending on the current road conditions.

**49)** To obtain the maximum efficiency of the braking system, a bedding-in period of about 500 km is needed: during this period it is better to avoid sharp, repeated and prolonged braking.

**50)** If the ABS system intervenes, this indicates that the grip of the tyres on the

road is about to reach its limit. You must slow down to a suitable speed.

**51)** The ABS cannot overrule the natural laws of physics, and cannot increase the grip available according to the condition of the road.

**52)** The ABS system cannot prevent accidents, including those due to excessive speed on corners, driving on low-grip surfaces or aquaplaning.

**53)** The capability of the ABS must never be tested irresponsibly and dangerously, in such a way as to compromise personal safety and the safety of others.

**54)** For the correct operation of the ABS, the tyres must of necessity be the same make and type on all wheels, in perfect condition and, above all, of the prescribed type and dimensions.

**55)** If the space-saver spare wheel (where present) is used, the ABS system keeps operating. Always remember that the space-saver wheel, being smaller than the original wheel, provides less grip.

**56)** The ABS gets the most from the available grip, but it cannot improve it; you should therefore take every care when driving on slippery surfaces and not take unnecessary risks.

**57)** For the correct operation of the ESC system, the tyres must necessarily be of the same make and type on all wheels, in perfect condition and, above all, of the prescribed type and size.

**58)** The ESC functions even when the space-saver wheel is being used. Always remember that the space-saver wheel, being smaller than the original wheel, provides less grip.

**59)** ESC performance features must not induce the driver to take unnecessary or unfounded risks. Your driving style must always be suited to the road conditions, visibility and traffic. The driver is always responsible for road safety.

**60)** The ESC system cannot alter the natural laws of physics, and cannot increase grip, which depends on the condition of the road.

**61)** The ESC system cannot prevent accidents, including those due to excessive speed on corners, driving on low-grip surfaces or aquaplaning.

**62)** The capability of the ESC system must never be tested irresponsibly and dangerously, in such a way as to compromise personal safety and the safety of others.

**63)** The HH system is not a parking brake, therefore do not leave the car without activating the handbrake, switching off the engine, and engaging first gear, with the car parked in safe conditions.

**64)** There may be situations on small gradients (less than 8%), with car laden or a trailer attached to it (where provided), in which the HH system may not activate, causing a slight reversing motion and increasing the risk of collision with another vehicle or object. The driver is, in any case, responsible for safe driving.

**65)** For the correct operation of the ASR system, it is essential that the tyres are of the same make and type on all wheels, in perfect condition and, above all, of the specified type and dimensions.

**66)** If the space-saver wheel (where provided) is used, the ASR system keeps operating. Always remember that the



space-saver wheel, being smaller than the original wheel, provides less grip.

**67)** The ASR cannot overrule the natural laws of physics, and cannot increase the grip available according to the condition of the road.

**68)** The ASR system cannot prevent accidents, including those due to excessive speed on corners, driving on low-grip surfaces or aquaplaning.

**69)** The capability of the ASR must never be tested irresponsibly and dangerously, in such a way as to compromise personal safety and the safety of others.

**70)** Do not take unnecessary risks, even if your vehicle is fitted with an ASR system. Your driving style must always be suited to the road conditions, visibility and traffic. The driver is always responsible for road safety.

**71)** The PBA system cannot increase tyre grip on the road over the limits imposed by laws of physics: always drive carefully according to the conditions of the road surface.

**72)** The PBA system cannot prevent accidents, including those due to excessive speed on bends, travelling on low-grip surfaces or aquaplaning.

**73)** The PBA system is an aid for the driver, who must always pay full attention while driving. The responsibility always rests with the driver.

**74)** The capability of the PBA system must never be tested irresponsibly and dangerously, in such a way as to compromise the safety of the driver, the other occupants of the car or any other road user.

## iTPMS (indirect Tyre Pressure Monitoring System)

(where provided)

### DESCRIPTION

The car can be equipped with the iTPMS (indirect Tyre Pressure Monitoring System) which monitors the tyre inflation status thanks to wheel speed sensors.

To access the iTPMS screens ( fig. 66 - fig. 67), press the TRIP button.

The fig. 67 screen will be displayed only if one or more tyres are flat.

### Correct tyre pressure

If the pressure of all the tyres corresponds to the correct value, the display shows the fig. 66 screen.

### Low tyre pressure

The system warns the driver if one or more tyres are flat by switching on the (⚠) warning light on the instrument panel.



66

AB0A0123C

The display will show "KO" beside the tyres fig. 67 along with a warning message.



67

AB0A0217C

If the system does not recognise the pressure value of one or more tyres, the display will show dashes "--"

This indication is displayed also when turning the engine off and on again until the RESET procedure is carried out.

## RESET PROCEDURE

The iTPMS needs an initial "self-learning" phase (with length depending on the driving style and road conditions: optimal conditions being driving on a straight road at 80 km/h for at least 20 minutes) which starts when the Reset procedure is carried out.

The Reset procedure must be carried out:

- ☑ each time tyre pressure is modified;
- ☑ when even only one tyre is changed;
- ☑ when tyres are rotated/inverted;
- ☑ when the space-saver wheel is fitted. Before carrying out the RESET procedure, inflate the tyres to the rated pressure values specified in the inflation pressure table (see "Wheels" paragraph in the "Technical specifications" chapter).

If the RESET is not carried out, in all above cases, the warning light may give false indications on one or more tyres.

To carry out the RESET procedure, with the car stopped and the ignition key at MAR, use the setup menu (see the description of the "Menu items" paragraph).

At the end of the Reset procedure the display will show the "Reset saved" message, indicating that the self-learning has been started.

## OPERATING CONDITIONS

 75) 76) 77) 78) 79) 80)

The system is active for speeds above 15 km/h.

In a few situations such as sporty driving, particular conditions of the road surface (e.g. icy, snowy, unsurfaced roads...) the warning may be delayed or partial in detecting the deflation of one or more tyres.

Under special conditions (e.g. car loaded asymmetrically on one side, damaged or worn tyre, fitting the space-saver spare wheel, fitting snow chains, fitting different tyres on the axles) the system may give false warnings or be temporarily deactivated. If the system is temporarily deactivated the  warning light flashes for about 75 seconds and then is continuously on; at the same time, the display shows a warning message.

This warning is displayed also after the engine has been switched off and then on again if the correct operating conditions are not restored. In the case of abnormal signals, it is recommended to perform the RESET procedure. If the warnings reappear once the RESET procedure has started, check that the same type of tyre is used on all four wheels and that the tyres are not damaged; if the space-saver spare

wheel is being used, refit a wheel with a tyre of normal dimensions in place of the space-saver wheel as soon as possible; if possible remove the snow chains; make sure that the load is distributed correctly and repeat the RESET procedure, driving on a clean and surfaced road. If the warning persist, contact an Abarth Dealership.



### WARNING

- 75)** If the system signals a pressure drop on one or more tyres, it is recommended to always check the pressure on all tyres.
- 76)** The iTPMS does not relieve the driver from the obligation to check the tyre pressure every month; the system does not replace servicing or operate as a safety system.
- 77)** Tyre pressure must be checked with tyres cold. Should it become necessary for whatever reason to check pressure with warm tyres, do not reduce pressure even though it is higher than the prescribed value, but repeat the check when tyres are cold.
- 78)** The iTPMS cannot indicate sudden tyre pressure drops (for example when a tyre bursts). In this case, stop the vehicle, braking with caution and avoiding abrupt steering.
- 79)** The system only warns that the tyre pressure is low: it is not able to inflate them.



**80)** *Insufficient tyre inflation increases fuel consumption, reduces the tread duration and may affect the capacity to drive safely.*

## OCCUPANT PROTECTION SYSTEMS

Some of the most important safety equipment of the car comprise the following protection systems:

- ☐ seat belts;
- ☐ SBR (Seat Belt Reminder) system;
- ☐ head restraints;
- ☐ child restraint systems;
- ☐ Front airbags and side bags (where present).

Read the information given the following pages with the utmost care. It is of fundamental importance that the protection systems are used in the correct way to guarantee the maximum possible safety level for the driver and the passengers.

For the description of the head restraint adjustment see the "Head restraints" paragraph in the "Knowing your car" chapter.

## SEAT BELTS

### USING THE SEAT BELTS

All vehicle seats are equipped with seat belts with three anchor points and a retractor. The driver is responsible for respecting, and ensuring that all the other occupants of the vehicle also respect, the local laws in force in relation to the use of the seat belts.

The belt should be worn keeping the torso straight and rested against the backrest.

To fasten the seat belts, hold fastening tongue (1) fig. 68 and insert it into buckle (2) fig. 68, until it clicks into place. On removal, if the belt jams, let it rewind for a short stretch, then pull it out again without jerking.

Press button (3) fig. 68 to release the belt.

Guide the belt while it is rewinding to prevent it from twisting.

The reel mechanism operates locking the belt in the event of sharp braking or strong deceleration due to an impact. This allows the belt strap to slide freely and to adapt to the body of the occupant. In the event of an accident, the belt will lock reducing the risk of impact inside the passenger compartment and of being projected outside the car.

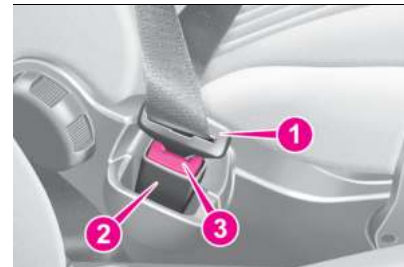

68

AB0A0059C

The retractor may lock when the car is parked on a steep slope: this is perfectly normal. Furthermore, the reel mechanism locks the belt if it is pulled sharply or in the event of sudden braking, collisions and high-speed bends.



The rear seat is fitted with inertia seat belts with three anchoring points and a retractor.

**NOTE** Wear the rear seat belts as shown in fig. 69.

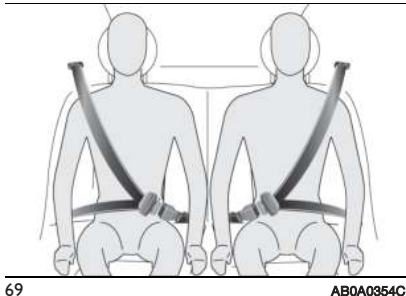

**WARNING** When putting the back seat to its normal position, make sure the seat belts are positioned so they are ready to use.

**WARNING**

- 81)** Never press button (3) when travelling.
- 82)** Remember that in the event of a violent impact the rear seat passengers not wearing seat belts are exposed to a very serious risk and also represent a serious danger for the front seat occupants.

## SBR SYSTEM (Seat Belt Reminder)

The SBR system warns the passengers of the front and rear (for versions/markets, where provided) seats if their seat belt is not fastened. The system indicates that seat belts are unfastened with visual warnings (warning lights on in the instrument panel and icons on the display) and/or an acoustic warning (see the following paragraphs).

**NOTE** Contact an Abarth Dealership to deactivate this acoustic warning permanently. The acoustic warning can be reactivated at any time through the display Setup Menu.

### Front seat belt warning light behaviour

When the ignition device is turned to MAR, the  warning light ((1) fig. 70 for the TFT panel or (1) fig. 71 for the TFT Sport panel) comes on for a few seconds, regardless of the status of the front seat belts.

With car moving slower than 20 km/h, if the driver side seat belt or the passenger side seat belt (with occupant seated) is unfastened, the warning light  stays on constantly.

As soon as a speed threshold of 20 km/h is reached, with driver side seat belt or the passenger side seat

belt (with occupant seated) unfastened, an acoustic warning is activated simultaneously with warning light  flashing for about 105 seconds.

Once activated, this indication cycle stays active for the entire time if the car is moving faster than 8 km/h or if reverse gear is not engaged or until the seat belts are fastened.

If the car speed drops to less than 8 km/h or if reverse gear is engaged during the warning cycle, the tone will be interrupted and the warning light  switches on fixed. If the entire time has not elapsed and reverse gear is not engaged, the warning cycle is reactivated as soon as the car speed exceeds 20 km/h again.

### Operation of rear seat belt icons for the TFT panel

The icons are shown on the display fig. 70 and fig. 71.



70

AB0A0443





71

AB0A0444

The displayed icons indicate:

(2): rear left seat belt;

(3): rear right seat belt.

With the car travelling as speed lower than 20 km/h, if a rear seat belt is unfastened, the icon stays on with fixed red light for a total of approximately 65 seconds.

The icons are displayed according to the corresponding rear seat belts and stay on for about 65 seconds from the last seat belt status change:

☐ if the seat belt is fastened the corresponding icon will be green;

☐ if the seat belt is unfastened the corresponding icon will be red.

If the car is travelling at a speed faster than 20 km/h and reverse is not engaged, if a rear seat belt is unbuckled, an acoustic warning is sounded when the icon blinks for approximately 35 seconds.

Successively, the acoustic warning is

deactivated and the icon lights up with fixed light until the end of the entire cycle.

Furthermore, the icons light up to indicate the status of the seat belts whenever one of the front doors is opened.

**WARNING** As far as the rear seats are concerned, the SBR system will only indicate whether the seat belts are unfastened or fastened, not the presence of any passengers.

The icons will activate a few seconds after the ignition device has been turned to MAR, regardless of the status of the seat belts (even if the seat belts are all fastened).

All icons light up when at least one belt changes from fastened to unfastened or vice versa and/or when one of the front doors is opened with the ignition device in the MAR position.

## PRE-TENSIONERS



The car is equipped with front seat belts pretensioners, that reduce slack in the belts in the event of a severe frontal collision. This guarantees the perfect adherence of the seat belts to the occupants' bodies before the restraining action begins.

It is evident that the pretensioners have operated when the belt withdraws towards the retractor.

This car is also equipped with a second pretensioner (fitted in the kick plate area). Its activation is signalled by the shortening of the metal cable.

A slight discharge of smoke may be produced during the activation of the pretensioner which is not harmful and does not involve any fire hazard.

**WARNING** To obtain the highest degree of protection from the action of the pretensioner, wear the seat belt tight to the chest and pelvis.

The pretensioner does not require any maintenance or lubrication: any changes to its original conditions will invalidate its efficiency. If, due to unusual natural events (floods, sea storms, etc.), the device has been affected by water or mud, have it replaced.  83)  18)

## LOAD LIMITERS

To increase passenger safety, the front seat belt reels contain a device which allows the force acting on the chest and shoulders to be modulated during the belt restraining action in the event of a frontal collision.

## GENERAL INSTRUCTIONS FOR USING THE SEAT BELTS

84) 85) 86)

Seat belts are also to be worn by pregnant women: the risk of injury in the case of a crash is greatly reduced for them and the unborn child if they are wearing a seat belt.

Pregnant women must position the lower part of the belt very low down so that it passes over the pelvis and under the abdomen (see fig. 72). While pregnancy progresses, the driver must adjust both seat and steering wheel to have full control over the vehicle (pedals and steering wheel must be easy to access). The maximum clearance should be kept between the abdomen and the steering wheel.

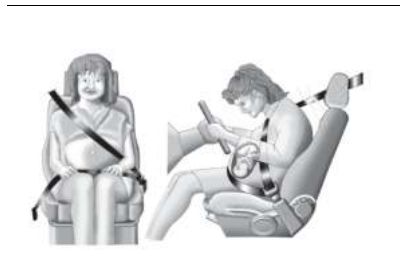

72

AB0A0347C

The belt strap must not be twisted. The upper part must pass over the shoulder and cross the chest diagonally. The lower part must adhere to the pelvis fig. 73, not to the abdomen of the occupant. Never use devices (clips, clamps, etc.) that hold the seat belt away from your body.



73

AB0A0348C

**WARNING** Each seat belt must be used by only one person. Never travel with a child sitting on the passenger's lap and a single belt to protect them

both fig. 74. In general, do not place any objects between the person and the belt.



74

AB0A0082C

## SEAT BELTS MAINTENANCE

For keeping the seat belts in efficient conditions, carefully observe the following warnings:

- ☑ always use the seat belt well stretched and never twisted; make sure that it is free to run without obstructions;
- ☑ check seat belt operation as follows: attach the seat belt and pull it hard;
- ☑ replace the belt after an accident of a certain severity even if it does not appear to be damaged. Always replace the belt if the pretensioners were deployed;
- ☑ prevent the retractors from getting wet: their correct operation is only guaranteed if water does not get inside;



☐ replace the seat belt when there is wear or cuts.



### WARNING

**83)** The pretensioner may be used only once. Contact an Abarth Dealership to have it replaced after it has been deployed.

**84)** For maximum safety, keep the seat backrest upright, lean back into it and make sure the seat belt fits closely across your chest and pelvis. Always fasten the seat belts on both the front and the rear seats! Travelling without wearing seat belts will increase the risk of serious injury or even death in the event of a crash.

**85)** Removing or tampering with seat belt and pretensioner components is strictly prohibited. Any intervention on these components must be performed by qualified and authorised technicians. Always contact an Abarth Dealership.

**86)** If the seat belt has been subjected to a high level of stress, for example after an accident, it must be completely replaced together with the anchorages, anchorage fixing screws and pretensioner. In fact, even if the seat belt has no visible defects, it could have lost its resilience.



### IMPORTANT

**18)** Operations which lead to impacts, vibrations or localised heating (over 100°C for a maximum of six hours) in the area around the pretensioner may damage or

deploy it. Contact an Abarth Dealership should intervention be necessary on these components.

## CHILD RESTRAINT SYSTEMS

### CARRYING CHILDREN SAFELY



For optimal protection in the event of an impact, all occupants must be seated and wearing adequate restraint systems, including newborn and children!

This prescription is compulsory in all EC countries according to EC Directive 2003/20/EC. Children below the height of 1.50 metres and up to 12 years must be protected with suitable restraint systems and be seated on the rear seats.

Statistics on accidents indicate that the rear seats offer greater safety for children.

Compared with an adult, a child's head is larger and heavier in proportion to their body and the child's muscular and bone structures are not fully developed. Therefore, correct restraint systems other than adult seat belts are necessary to reduce as much as possible the risk of injuries in the event

of an accident, braking or a sudden manoeuvre.

Children must be seated safely and comfortably. As far as the characteristics of the child seats used allow, you are advised to keep children in rear facing child seats for as long as possible (at least until 3–4 years old), since this is the most protected position in the event of a collision.

The choice of the most suitable child restraint system depends on the weight and size of the child. There are various types of child restraint systems, which can be secured to the car by means of the seat belts or with the ISOFIX anchorages.

It is recommended to always choose the restraint system most suitable for the child; for this reason always refer to the Owner Handbook provided with the child restraint system, to be sure that it is of the right type for the children it is intended for.

For correct installation on the car, some universal child restraint systems require an accessory (base) sold separately by the restraint system's producer. Therefore, FCA advises customers to check that their chosen child restraint system can be installed on their vehicle by performing a trial installation, on the vendor's premises, before purchase.



## WARNING

**87) SERIOUS DANGER.** When an active passenger airbag is fitted, **DO NOT** install rear facing child restraint systems on the front seat. Deployment of the airbag in an accident could cause fatal injuries to the child regardless of the severity of the impact. It is advisable to always carry children in a child restraint system on the rear seat, which is the most protected position in the event of a collision.

**88)** On the sun visor there is a label with suitable symbols reminding the user that it is compulsory to deactivate the airbag if a rearward facing child restraint system is fitted. Always comply with the instructions on the passenger side sun visor (see the "Front airbags" paragraph).

**89)** Should it be necessary to carry a child on the passenger side front seat in a rear facing child restraint system, the passenger side front and side airbags must be deactivated through the display main menu, verifying deactivation by checking that the warning light  located in the central part of the dashboard has switched on. Move the passenger's seat as far back as possible to avoid contact between the child seat and the dashboard.

**90)** Do not move the front or rear seat if a child is seated on it or on the dedicated child restraint system.



## CHILD RESTRAINT SYSTEMS

In Europe the characteristics of child restraint systems are ruled by the regulation ECE-R44, dividing them into five weight groups:

Group	Age	Weight	Size class/Fixing
0	Indicatively up to 9 months	Up to 10 kg	ISO/L1
			ISO/L2
			ISO/R1
0+	Indicatively up to 2 years	Up to 13 kg	ISO/R1
			ISO/R2
			ISO/R3
1	Indicatively from 8 months to 4 years	9 kg - 18 kg	ISO/R2
			ISO/R3
			ISO/F2
			ISO/F2X
2	Indicatively from 3 to 7 years	15 kg - 25 kg	ISO/F3
			-
3	Indicatively from 6 to 12 years	22 kg - 36 kg	-

All restraint devices must bear the type-approval data, together with the control mark, on a label solidly fixed to the child restraint system which must never be removed.

Lineaccessori Abarth offers child restraint systems for each weight group. These devices are recommended having been specifically designed for Abarth cars.

## FITTING A CHILD RESTRAINT SYSTEM WITH SEAT BELTS

91) 92) 93) 94)

The Universal child restraint systems installed with the seat belts only are type-approved on the basis of the ECE R44 standard and are divided into various weight groups.

**WARNING** The figures are indicative and provided for assembly purposes only. Fit the child restraint system according to the instructions, which must be included.

### GROUP 0 and 0+

Infants up to 13 kg must be carried with a rearward facing child restraint system of the type shown in fig. 75 which, supporting the head, does not induce stress on the neck in the event of sudden decelerations.

The child restraint system is restrained by the vehicle seat belts, as shown in fig. 75 and it must restrain the child in turn with its own belts.



75

AB0A0063C

### GROUP 1

Children weighing from 9 to 18 kg may be transported in forward facing child restraint systems fig. 76.



76

AB0A0064C

### GROUP 2

Children from 15 to 25 kg may be restrained directly by the car seat belts fig. 77.



77

AB0A0065C

In this case, the child restraint system is used to position the child correctly with respect to the seat belts so that the diagonal belt section crosses the child's chest and not the neck, and the lower part is snug on the pelvis not the abdomen.

### GROUP 3

For children between 22 and 36 kg, there are dedicated restraint systems that allow the seat belt to be worn correctly.

The fig. 78 shows the correct child positioning on the rear seat.





78

AB0A0068C

Children over 1.50 m in height can wear seat belts like adults.

### INSTALLING AN ISOFIX CHILD RESTRAINT SYSTEM



The car is equipped with ISOFIX anchorages, a new standard which makes fitting a child restraint system quick, simple and safe.

The ISOFIX system lets you install the ISOFIX child restraining system without using the car seat belts but connecting them directly to the car seat with three anchorages in the car. Traditional child restraint systems can be fitted alongside ISOFIX child restraint systems on different seats in the same vehicle.

To install an ISOFIX child restraint system, attach it to the two metal anchors (1) fig. 79 located in the rear seat cushion, in the point where the

seat cushion meets the backrest, remove the parcel shelf and fix the upper strap (provided with the child restraint system) to the dedicated anchor (2) fig. 80 located at the bottom of the seat back.

**WARNING** The central rear seat is not approved for any type of ISOFIX child restraint system.

fig. 81 shows an example of a Universal ISOFIX child restraint system for weight group 1.

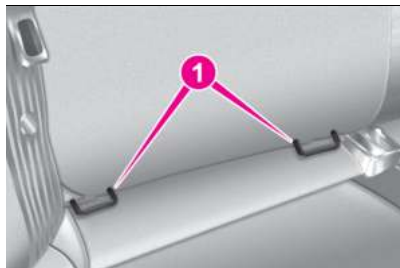

79

AB0A0068C

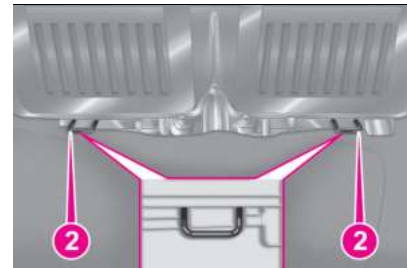

80

AB0A0068C

**WARNING** The diagram is indicative and for fitting purposes only. Fit the child restraint system according to the instructions, which must be included.

**NOTE** When a Universal ISOFIX child restraint system is used, only ECE R44 "ISOFIX Universal" (R44/03) or later type-approved child restraint systems can be used.



81

AB0A0067C



## WARNING

**91)** Child restraint systems with ISOFIX attachments are available for safe anchoring to the seat without using the car seat belts. See paragraph "Installing an ISOFIX child restraint system" for the installation instructions.

**92)** Incorrect fitting of the child restraint system may result in an inefficient protection system. In the event of an accident the child restraint system may become loose and the child may be

*injured, even fatally. When fitting a restraint system for newborns or children, strictly comply with the instructions provided by the Manufacturer.*

**93)** When the child restraint system is not used, secure it with the seat belt or with the ISOFIX anchorages, or remove it from the car. Do not leave it unsecured inside the passenger compartment. In this way, in the event of sudden braking or an accident, it will not cause injuries to the occupants.

**94)** After installing a child restraint system, do not move the seat: always remove the child restraint system before making any adjustment.

**95)** If a Universal ISOFIX child restraint system is not fixed to all three anchorages, it will not be able to protect the child correctly. In a crash, the child could be seriously or fatally injured.

**96)** Fit the child restraint system when the car is stationary. The child restraint system is correctly fixed to the brackets when you hear the click. Follow the instructions for assembly, disassembly and positioning that the Manufacturer must supply with the child restraint system.

**97)** Always make sure that the chest section of the seat belt does not pass under the arms or behind the back of the child. In the event of an accident the seat belt will not be able to secure the child, with the risk of injury, including fatal injury. Therefore the child must always wear the seat belt correctly.

**98)** Never use the same lower anchorage to attach more than one child restraint.



## Child restraint system installation

The table provides guidelines on positioning child restraint systems on the car seats. Each child restraint system position complies with the UNECE standards.



Seat number	Number of seats						
	1	2	3		4	5	6
			Airbag ENABLED	Airbag DISABLED			
Seat suitable for rearward facing child restraint systems (U)	X	X	NO	YES	YES	X	YES
Seat suitable for forward facing child restraint systems (UF)	X	X	YES (a)	NO	YES	X	YES
i-Size seat (i-U)	X	X	NO	NO	NO	X	NO (1)
Seat suitable for ISOFIX side fixtures (L1 / L2)	X	X	NO	NO	NO	X	NO
Seat suitable for ISOFIX rearward facing fixtures (R1/ R2 / R3) (IL)	X	X	NO	NO	NO	X	R2 only **
Seat suitable for ISOFIX forward facing fixtures (F2/ F2X / F3) (IUF)	X	X	NO	NO	YES	X	YES

Seat number	Number of seats						
	1	2	3		4	5	6
			Airbag ENABLED	Airbag DISABLED			

Seat suitable for forward facing Booster fixtures (B2/B3 fixtures)	X	X	NO	NO	NO (1)	X	Only B2
--	---	---	----	----	--------	---	---------

U = Position suitable for a "universal" child restraint system approved for this weight category.

UF = Position suitable for a "universal" forward facing child restraint system approved for this weight category.

IUF = Position suitable for an "ISOFIX" universal forward facing child restraint system approved for this weight category.

i-U = Position suitable for an i-Size "universal" forward facing or rearward facing child restraint system.

i-UF = Position suitable for an i-Size "universal" forward facing child restraint system.

IL = Position suitable for specific listed ISOFIX child restraint systems (CRS). These ISOFIX CRS are classified as "car-specific", "restricted use" and "semi-universal".

X = Not applicable. The seat is not approved for installation of child restraint systems.

(a) = With forward facing child restraint system, the seat must be positioned no more forward than the longitudinal halfway point.

\*\* = Installation only possible by moving the corresponding front seat forward. In this configuration, the seat must not be occupied.

(1) = This seat is not approved for use with this category of child restraint systems. Nevertheless, it may still be possible to install this category of child restraint system. Therefore, check the compatibility of this vehicle with the identified child restraint system on the manufacturer's website.



## Child restraint system installation (right-hand drive version)

The table provides guidelines on positioning child restraint systems on the car seats. Each child restraint system position complies with the UNECE standards.



Seat number	Number of seats						
	1		2	3	4	5	6
	Airbag ENABLED	Airbag DISABLED					
Seat suitable for rearward facing child restraint systems (U)	NO	YES	X	X	YES	X	YES
Seat suitable for forward facing child restraint systems (UF)	YES (a)	NO	X	X	YES	X	YES
i-Size seat (i-U)	NO	NO	X	X	NO (1)	X	NO
Seat suitable for ISOFIX side fixtures (L1 / L2)	NO	NO	X	X	NO	X	NO
Seat suitable for ISOFIX rearward facing fixtures (R1/ R2 / R3) (IL)	NO	NO	X	X	R2 only **	X	NO
Seat suitable for ISOFIX forward facing fixtures (F2/ F2X / F3) (IUF)	NO	NO	X	X	YES	X	YES

Number of seats							
Seat number	1		2	3	4	5	6
	Airbag ENABLED	Airbag DISABLED					

Seat suitable for forward facing Booster fixtures (B2/B3 fixtures)

NO	NO	X	X	Only B2	X	NO (1)
----	----	---	---	---------	---	--------

U = Position suitable for a "universal" child restraint system approved for this weight category.

UF = Position suitable for a "universal" forward facing child restraint system approved for this weight category.

IUF = Position suitable for an "ISOFIX" universal forward facing child restraint system approved for this weight category.

i-U = Position suitable for an i-Size "universal" forward facing or rearward facing child restraint system.

i-UF = Position suitable for an i-Size "universal" forward facing child restraint system.

IL = Position suitable for specific listed ISOFIX child restraint systems (CRS). These ISOFIX CRS are classified as "car-specific", "restricted use" and "semi-universal".

X = Not applicable. The seat is not approved for installation of child restraint systems.

(a) = With forward facing child restraint system, the seat must be positioned no more forward than the longitudinal halfway point.

\*\* = Installation only possible by moving the corresponding front seat forward. In this configuration, the seat must not be occupied.

(1) = This seat is not approved for use with this category of child restraint systems. Nevertheless, it may still be possible to install this category of child restraint system. Therefore, check the compatibility of this vehicle with the identified child restraint system on the manufacturer's website.



### Main recommendations to carry children safely

- ▣ Install the child restraint systems on the rear seat, which is the most protected position in the event of an impact.
- ▣ Keep children in rearward facing child restraint systems for as long as possible, ideally until they are 2 years old.
- ▣ Should a rearward facing child restraint system be installed on the rear seats, it is advisable to position it as far forward as the position of the front seat allows.
- ▣ If the passenger's front airbag is deactivated always check the permanent switching on of the  warning light to make sure that it has actually been deactivated.
- ▣ Carefully follow the instructions supplied with the child restraint system. Keep the instructions in the vehicle along with the other documents and this handbook. Do not use second-hand child seats without instructions.
- ▣ Only one child is to be strapped into each restraint system; never carry two children simultaneously.
- ▣ Always check that the seat belts do not rest on the child's neck.
- ▣ Always check that the seat belt is well fastened by pulling on it.

- ▣ While travelling, do not let the child sit incorrectly or unfasten the belts.
- ▣ Never allow a child to put the belt's diagonal section under an arm or behind their back.
- ▣ Never carry children on your lap, even newborns. No-one can hold a child in the case of a crash.
- ▣ In the event of an accident, replace the child restraint system with a new one. In addition, and depending on the type of child restraint system installed, replace the ISOFIX anchorages or the seat belt with which the child restraint system was connected.
- ▣ The rear headrest (where provided) can be removed if needed to install a child restraint system. The headrest must always be fitted in the car if the seat is used by an adult passenger or a child sitting in a restraint system without a backrest.

## SUPPLEMENTARY RESTRAINT SYSTEM (SRS) - AIRBAG

The car may be equipped with:

- ▣ front driver airbag;
- ▣ front passenger airbag;
- ▣ driver's side knee bag;
- ▣ driver and passenger front side bags for pelvis, chest and shoulder protection (Side bags);
- ▣ side bags for head protection of front seat passengers and rear side seat passengers (window bag).

### FRONT AIRBAGS



The front driver/passenger airbags and the driver's knee bag (where provided) protect the front seat occupants in the event of frontal impacts of medium/high severity, by placing the bag between the occupant and the steering wheel or dashboard.

Therefore non-activation of airbags in other types of collisions (side impacts, rear shunts, roll-overs, etc.) does not indicate a system malfunction.

An electronic control unit will make the bag inflate in the event of a frontal impact.

The bag will inflate instantaneously placing itself between the front

occupants body and the structures which could cause injury. It will deflate immediately afterwards.

Front airbags are not a replacement of but complementary to the seat belts, which you are recommended to always wear, as specified by law in Europe and most non-European countries.

In the event of an impact, someone not wearing a seat belt could move forward and come into contact with a bag which is still opening. The protection offered by the bag is compromised in these circumstances.

Front airbags may not activate in the following situations:

- ▣ frontal impacts against highly deformable objects not involving the front surface of the car (e.g. wing collision against guard rail);
- ▣ car wedging under other vehicles or safety barriers (e.g. trucks or guard rails).

Failure to activate in the conditions described above is due to the fact that they may not provide any additional protection compared with seat belts, so their activation would be inappropriate. In these cases, non-deployment does not indicate a system malfunction.

The front airbags (driver, passenger, driver's knee bags) are designed

and calibrated to protect front seat passengers wearing seat belts.

Their volume at the moment of maximum inflation fills most of the space between the steering wheel and the driver, between the lower post guard and the knees on passenger side and between the dashboard and the passenger.

The airbags are not deployed in the event of minor frontal impacts (for which the restraining action of the seat belts is sufficient).

Seat belts must always be worn. In the event of a frontal collision, they ensure the correct positioning of the occupant.

### Driver's side front airbag



101)

This consists of an instantly inflating bag contained in a special recess in the centre of the steering wheel fig. 82.



82

AB0A0289C

### Passenger front airbag

This consists of an instantly inflating bag contained in a special compartment in the dashboard fig. 83: this bag has a larger volume than the driver's.

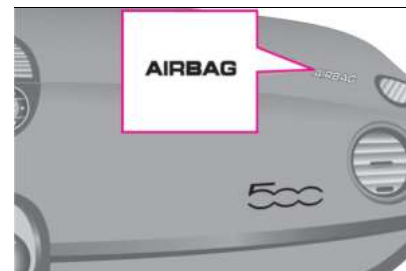

83

AB0A0071C

### Passenger's front airbag and child restraint systems



102)

Rearward facing child restraint systems must NEVER be fitted on the front seat with an active passenger side airbag since, in the event of a crash, the airbag activation could cause fatal injuries to the transported child.

**ALWAYS** comply with the instructions on the label on the passenger side sun visor (fig. 84 and fig. 85).





84

AB0A0307C



85

AB0A0308C

### PASSENGER AIRBAG DEACTIVATION: FRONT AIRBAG AND FRONT SIDE AIRBAG (SIDE BAG)



103) 104)

If a child must be carried on the front seat in a rearward facing child restraint system, deactivate the passenger side front airbag and front side bag. Warning light (1) fig. 86 will stay on constantly until the passenger side

front airbag and the front side bag are reactivated.



86

AB0A0228C

WARNING To manually deactivate the passenger side front airbag and the front side bag, see paragraph "Menu items" in the "Knowing the instrument panel" chapter.

### Driver side knee bag (where provided)

It consists of an instantly inflating cushion contained in a special compartment (3) under the lower steering column guard fig. 87 at driver's knee level. It provides further protection to the driver in the event of a frontal impact.



87

AB0A0073C



### WARNING



**99)** Do not apply stickers or other objects on the steering wheel, on the dashboard in the passenger side airbag area, on side upholstery on the roof or on the seats. Never put objects (e.g. mobile phones) on the passenger side of the dashboard since they could interfere with correct inflation of the passenger airbag and also cause serious injury to the passengers.

**100)** Do not travel with objects in your lap, in front of your chest or held in your mouth (e.g., pipe, pencil etc.). They could cause severe injury if the airbag is deployed in a crash.

**101)** The airbag must be able to inflate without obstruction in the event of deployment. It is therefore recommended not to drive with the body bent forward, but to sit up resting your back and shoulders on the backrest of the seat. Adjusting the position of the seat so that you can reach and manoeuvre the steering wheel comfortably with your arms slightly bent being as far away as possible from

the steering wheel. Being too close to the steering wheel when the airbag is deployed may cause serious injury.

**102)** When there is an active passenger airbag, **DO NOT** install rearward facing child restraint systems on the front seat. Deployment of the airbag in a crash could cause fatal injuries to the child regardless of the severity of the collision. Therefore, always deactivate the passenger side airbag when a rearward facing child restraint system is installed on the front passenger seat. The front passenger seat must also be positioned back as far as possible in order to prevent the child restraint system from coming into contact with the dashboard. Immediately reactivate the passenger airbag as soon as the child restraint system has been removed.

**103)** A failure of the  warning light is indicated by the  symbol on the display.

In this case, the  warning light may not indicate a possible problem with the airbag restraint system. Before driving off, contact an Abarth Dealership to have the system checked immediately.

**104)** The  warning light indicates the passenger airbag protection status. If the warning light is off, passenger side protection is active: to deactivate it, use the Setup Menu (in this case the LED lights up). When the car is started (ignition key turned to MAR position), the warning light turns on for about 8 seconds, provided that at least 5 seconds have elapsed from when it was switched off. If not, contact an Abarth Dealership. If the engine is switched off/on again in less than 5 seconds the warning light may remain off. In this case, to check correct warning light

operation, switch the engine off, wait for at least 5 seconds and switch the engine on again. The warning light may light up with various intensity levels depending on the vehicle conditions. The intensity may also vary during the same key cycle.



## Passenger's front airbag and child restraint systems: IMPORTANT

<b>I</b>	RISCHIO DI FERITE GRAVI O MORTALI. I seggiolini bambino che si montano nel verso opposto a quello di marcia non vanno installati sui sedili anteriori in presenza di air bag passeggero attivo.
<b>GB</b>	DEATH OR SERIOUS INJURY CAN OCCUR. NEVER use a rearward facing child restraint on a seat protected by an ACTIVE AIRBAG in front of it, DEATH or SERIOUS INJURY to the CHILD can occur
<b>F</b>	RISQUE DE MORT OU DE BLESSURES GRAVES. NE PAS positionner le siège pour enfant tourné vers l'arrière, en cas d'air bag passager actif.
<b>D</b>	Nichtbeachtung kann TOD oder SCHWERE VERLETZUNGEN zur Folge haben. Rückwärts gerichtete Kinderrückhaltesysteme (Babyschale) dürfen nicht in Verbindung mit aktiviertem Beifahrerairbag auf dem Beifahrersitz verwendet werden
<b>NL</b>	DIT KAN DODELIJK ZIJN OF ERNSTIGE ONGELUKKEN VEROORZAKEN. Plaats het kinderstoeltje niet ruggelings op de voorstoel wanneer er een airbag aanwezig is.
<b>E</b>	PUEDE OCACIONAR MUERTE O HERIDAS GRAVES. NO ubicar el asiento para niños en sentido inverso al de marcha en el asiento delantero si hubiese airbag activo lado pasajero.
<b>PL</b>	MOŻE GROZIĆ ŚMIERCIĄ LUB CIEŻKIMI OBRAŻENIAMI. NIE WOLNO umieszczać fioletika dziecięcego tyłem do kierunku jazdy na przednim siedzeniu w przypadku zainstalowanej aktywnej poduszki powietrznej pasażera.
<b>TR</b>	ÖLÜM VEYA AĞIR ŞEKİLDE YARALANMAYA SEBEP OLABİLİR. Yolcu airbağı aktif halde iken çocuk koltuğunu araç gidis yönüne ters biçimde yerleştirmeyin.
<b>DK</b>	FARE FOR DØDELIGE KVÆSTELSER OG LIVSTRUENDE SKADER. Placer aldrig en bagvendt barnestol på passagerersædet, hvis passager-airbagen er indstillet til at være aktiv (on).
<b>EST</b>	TAGAJÄRJEKS VÕIVAD OLLA TÕSISED KEHAVIGASTUSED VÕI SURM. Turvapadja olemasolu korral ärge asetage lapse turvaistet sõidusuunaga vastassuunas.
<b>FIN</b>	KUOLEMANVAARA TAI VAKAVIEN VAMMOJEN UHKA. Älä aseta lasten turvaistuinta niin, että lapsi on selkää menosuuntaan, kun matkustajan airbag on käytössä.
<b>P</b>	RISCO DE MORTE OU FERIMENTOS GRAVES. Não posicionar o banco para crianças numa posição contrária ao sentido de marcha quando o airbag de passageiro estiver activo.
<b>LT</b>	GAJI ĮSTIKTI MIRTIS ARBA GALITE RIMTAI SUSIŽEISTI. Nedėkite vaiko sėdynės atgretos nugarą į priekinį automobilio stiklą ten, kur yra veikiant keleivio oro pagalvė.
<b>S</b>	KAN VARA LIVSHOTANDE ELLER LEDA TILL ALLVARLIGA SKADOR. Placera aldrig en bakåtvänd barnstol i framsätet då passagerarsidans krockkudde är aktiv.
<b>H</b>	HALÁSOS VAGY SÚLYOS BALESET KÖVETKEZHET BE. Ne helyezzük a gyermekülést a menetiránnyal szembe, ha az utas oldalán légszák működik.
<b>LV</b>	VAR IZRAIŠĪT NĀVI VAI NOPIETNAS TRAUMAS. Nenovietot mazļa sēdekli pretēji braukšanas virzienam, ja pasažiera pusē ir uzstādīts gaisa spilvens.
<b>CZ</b>	HROZÍ NEBEZPEČÍ VÁŽNĚHO UBLIŽENÍ NA ZDRAVÍ NEBO DOKONCE SMRTI. Neumísťujte detskú sedačku do opačné polohy vŕči smeru jazdy v prípade aktívneho airbagu spolujazdca.
<b>SLO</b>	LAHKO PRIDE DO SMRTI ALI HUDIH POŠKODB. Otroškega avtomobilskega sedeža ne nameščajte v obratni smeri vožnje, če ima vozilo vgrajene zračne blazine za potnike.
<b>RO</b>	SE POATE PRODUC DECESUL SAU LEZIUNI GRAVE. Nu aşezaţi scaunul de maşină pentru bebeluşi în poziţie contrară direcţiei de mers atunci când airbag-ul pasagerului este activat.
<b>GR</b>	ΜΠΟΡΕΙ ΝΑ ΠΡΟΚΛΗΘΟΥΝ ΘΑΝΑΤΟΣ Ή ΣΟΒΑΡΑ ΤΡΑΥΜΑΤΑ. Μην τοποθετείτε το καρεκλάκι αυτοκινήτου για παιδιά σε αντίθετη προς την φορά πορείας θέση σε περίπτωση που υπάρχει αερόσακος εν ενεργεία στη θέση συνεπιβάτη.
<b>BG</b>	ИМА ОПАСНОСТ ОТ СМЪРТ И СЕРИОЗНИ НАРАНЯВАНИЯ. Не поставяйте столчето за пренасяне на бебета в положение обратно на посоката на движение, при положение активно на въздушната възглавница за пътуване.
<b>SK</b>	MŮŽE NASTAŤ SMŤ ALEBO VÁŽNE ZRANENIA. Nedávajte autosedačku pre deti do polohy proti chodu vozidla, keď je aktívny airbag spolujazdca.
<b>RUS</b>	ТРАВМЫ И ЛЕТАЛЬНЫЙ ИСХОД. Детское кресло, устанавливаемое против направления движения, нельзя монтировать на месте переднего пассажира, если последнее оборудовано активной подушкой безопасности.
<b>HR</b>	OPASNOST OD TEŠKIH ILI SMRTONOSNIH OZLJEDA. Sjedala za djecu koja se montiraju u smjeru suprotnom od vožnje ne smiju se instalirati na prednja sjedala ako postoji aktivni zračni jastuk suvozača.
<b>AS</b>	قد تحدث حالات وفاة أو إصابات بالغة. لا تستخدم مقاعد الأمان الخاصة بالأطفال على مقعد مزود "بوسادة هوائية"، حيث إن الطفل قد يتعرض للوفاة أو لإصابة بالغة.

## SIDE BAGS - WINDOW BAGS

(where provided)

To increase protection of occupants in the event of side collision, the car is equipped with side bags for pelvis, chest and shoulder protection for the driver and the passenger and airbags protecting the head. Non-activation of side bags in other types of collisions (front collisions, rear shunts, roll-overs, etc.) is not a system malfunction.

### Front side airbags (Side bags)

These comprise two types of bags located in the front seat backrests fig. 89 which protect the pelvis, chest and shoulder area of the occupants in the event of a side collision of medium-high severity.

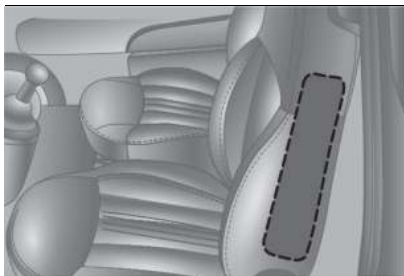

89

AB0A0074C

### Window bags

These comprise two window bags located behind the side lining of the roof and covered by special trim fig. 90.

They are designed to protect the head of front and rear side occupants in the event of side collisions, thanks to their wide inflation surface.

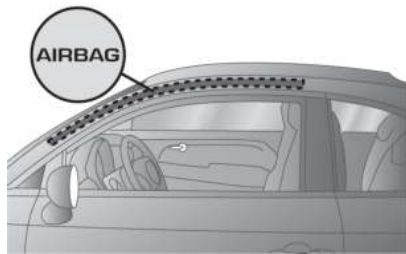

90

AB0A0075C

### Important notes

In the event of a side impact, the system provides best protection if the passenger sits on the seat in a correct position, thus allowing correct window bag deployment.

The front airbags and/or side bags may be deployed if the car is subject to heavy knocks or accidents involving the underbody area, such as for example violent shocks against steps, pavements or low obstacles, the car falling in big holes or dips in the road. A small amount of dust will be released when the airbags are deployed. The dust is not harmful and does not indicate the beginning of a fire. Furthermore, the surface of the deployed bag and the interior of the car

may be covered by a dusty residue: this may irritate skin and eyes. Wash with neutral soap and water in the event of exposure.

Every control, repair and replacement operation concerning the airbags must only be carried out at an Abarth Dealership. If the car is scrapped, have the system deactivated at an Abarth Dealership.

Pretensioners, front airbags and side bags are deployed according to different logics on the basis of the type of crash. Failure to activate one or more of the devices does not indicate a system malfunction.

Should an accident occur in which any of the safety devices are activated, take the car to an Abarth Dealership to have the activated devices replaced and to have the whole system checked.

 105) 106) 107) 108) 109) 110) 111) 112) 113) 114) 115) 116)



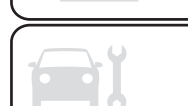

### WARNING

**105)** *If when turning the key to MAR the warning light  does not turn on or stays on whilst driving, a failure may have occurred in the restraint systems. In this case the airbags or pretensioners may not be deployed in an impact or, in a lower number of cases, they may be deployed accidentally. Before driving off, contact*



an Abarth Dealership to have the system checked immediately.

**106)** In some versions, in case of LED failure  (located on the plate of the instrument panel), the warning light  on the console turns on and the passenger side airbags are deactivated.

**107)** Do not cover the front seat backrests with extra covers if they are equipped with side bags.

**108)** If the car has been subject to theft, attempted theft, vandalism, or flooding, have the airbag system inspected at an Abarth Dealership.

**109)** If the starter switch is at MAR, even if the engine is switched off, airbags may be deployed when the car is stationary and hit by another car. Therefore, even if the vehicle is stationary, when an active front passenger airbag is fitted, DO NOT install rearward facing child restraint systems on the front passenger seat. Deployment of the airbag following an impact could cause fatal injuries to the child. Therefore, always deactivate the passenger side airbag when a rearward facing child restraint system is installed on the front passenger seat. The front passenger seat must also be positioned back as far as possible in order to prevent the child restraint system from coming into contact with the dashboard. Immediately reactivate the passenger airbag as soon as the child restraint system has been removed. Also remember that, if the ignition device is set to STOP, none of the safety devices (airbags or pretensioners) will be deployed in the event of collision. Non-deployment in such cases does not indicate a system malfunction.

**110)** When the ignition key is turned to MAR, the  warning light switches for few seconds, then if the passenger airbag is active it should switch off.

**111)** Do not wash the seats with water or pressurised steam (wash by hand or at automatic seat washing stations).

**112)** The front airbag deployment threshold is higher than that of the pretensioners. For collisions in the range between the two thresholds, it is normal for only the pretensioners to be activated.

**113)** Do not affix rigid objects to the coat hooks or support handles.

**114)** The airbag does not replace seat belts but increases their efficiency. Furthermore, since front airbags are not deployed in low-speed frontal impacts, side impacts, rear shunts or roll-overs, the passengers are protected only by the seat belts which must therefore be fastened at all times.

**115)** Do not rest your head, arms or elbows on the door, on the windows or in the window bag area to prevent injury during deployment.

**116)** Never lean your head, arms or elbows out of the window.

# STARTING AND DRIVING

*We have now reached the "heart" of the car: let's see how to use the car to its full potential.*

*We'll look at how to drive safely in any situation, making it a welcome companion with our comfort and wallets in mind.*

STARTING THE ENGINE .....	94
WHEN PARKED .....	95
USING THE MANUAL TRANSMISSION .....	95
USING THE ROBOTISED SEQUENTIAL TRANSMISSION .....	96
DUALDRIVE ELECTRIC POWER STEERING .....	99
SPORT FUNCTION.....	100
PARKING SENSORS .....	101
REFUELLING THE CAR .....	103
SAVING FUEL.....	104



## STARTING THE ENGINE





The car is fitted with an electronic engine lock device: if the engine fails to start, see the paragraph "Fiat CODE system" in the "Knowing your car" chapter.

### PROCEDURE

Proceed as follows:

- ☐ engage the handbrake and put the gear lever in neutral;
- ☐ fully depress the clutch pedal without touching the accelerator;
- ☐ turn the ignition key to AVW and release it as soon as the engine starts. If the engine does not start at the first attempt, return the ignition key to STOP before repeating the starting procedure.

If, with key at MAR, the  symbol on the display stays on together with the  warning light on the instrument panel, it is advisable to turn the key to STOP and then back to MAR. If the warning light remains on, try with the other keys provided with the car. Contact an Abarth Dealership if you still cannot start the engine.



19) 20)



117) 118)

## WARMING UP THE ENGINE JUST AFTER IT HAS STARTED

Proceed as follows:

- ☐ drive off slowly, letting the engine turn at medium revs. Do not accelerate abruptly;
- ☐ do not demand full performance at first. It is advisable to wait until the engine coolant temperature indicator starts moving.



21)

## STOPPING THE ENGINE

Turn the ignition key to STOP while the engine is idling.

**WARNING** After a taxing drive, you should allow the engine to "catch its breath" before turning it off by letting it idle to allow the temperature in the engine compartment to fall.



22)



### WARNING

**117)** It is dangerous to run the engine in enclosed areas. The engine consumes oxygen and engine exhaust contains carbon dioxide, carbon monoxide and other toxic gasses.

**118)** Remember that the brake servo and electric power steering are not operational

*until the engine has been started, therefore much effort than usual is required on the brake pedal and steering wheel.*



### IMPORTANT

**19)** It is advisable not to demand maximum performance from your car (e.g. excessive acceleration, long distances at maximum rpm, excessively intense braking, etc.) when it is first used.

**20)** When the engine is switched off never leave the key turned to MAR-ON to prevent useless current absorption from draining the battery.

**21)** Never, under any circumstances, jump start the engine by pushing, towing or coasting downhill. This could cause fuel to flow into the catalytic converter and damage it beyond repair.

**22)** A quick burst on the accelerator before stopping the engine serves no practical purpose; it wastes fuel and is especially damaging to turbocharged engines.

## WHEN PARKED

When parking and leaving the car, proceed as follows:

☐ engage a gear (1<sup>st</sup> gear if facing uphill or reverse if facing downhill) and leave the wheels turned;

☐ stop the engine and engage the handbrake;

☐ always remove the ignition key.

Block the wheels with a wedge or a stone if the car is parked on a steep slope.

On versions equipped with sequential robotised transmission, wait for letter P to be displayed before releasing the brake pedal.

**WARNING NEVER** leave the car with the gearbox in neutral (or, on versions equipped with sequential robotised transmission, before placing the gear lever at P).



119)

### HANDBRAKE

The handbrake lever (1) fig. 91 is located between the two front seats.

To use the handbrake pull the lever upwards until the car cannot be moved.



120)

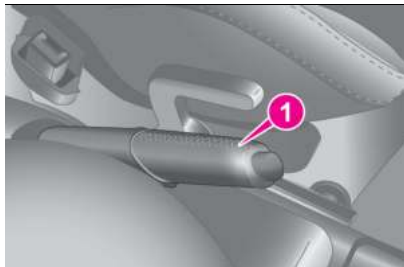

91

AB0A0076C

When the handbrake is on and the ignition key is at MAR, the instrument panel warning light (1) will come on.

Proceed as follows to release the handbrake:

☐ slightly lift the lever and press the release button on the lever (1) fig. 91;

☐ keep the button pressed and lower the lever. The (1) warning light in the instrument panel will switch off.

Press the brake pedal when carrying out this operation to prevent the car from moving accidentally.



### WARNING

**119)** *Never leave children unattended in the car. Always remove the key from the ignition device when leaving the car and take it with you.*

**120)** *The car should be braked after a few clicks of the lever. If it is not, contact an Abarth Dealership to have it adjusted.*

## USING THE MANUAL TRANSMISSION

To engage the gears, press the clutch pedal fully and put the gear lever into the required position (the diagram for gear engagement is shown on the grip fig. 92).



121)



23)

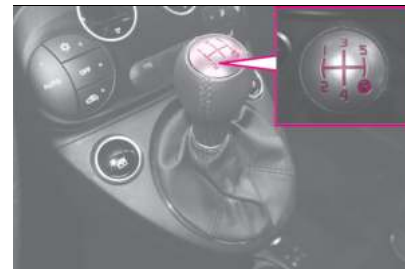

92

AB0A0301C

To engage reverse gear R from neutral, move the lever to the right and then backwards

**WARNING** Reverse can only be engaged when the car is completely stationary. With the engine running, wait for at least 2 seconds with the clutch pedal fully depressed before engaging reverse to prevent damage to the gears and grating.

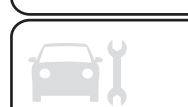

**WARNING** The clutch pedal should be used only for gear changes. Do not drive with your foot resting on the clutch pedal, however lightly. Where present, the electronic clutch control could cut in by interpreting the incorrect driving style as a fault.



### WARNING

**121)** Press the clutch pedal fully to shift gears correctly. It is therefore essential that there is nothing under the pedals: make sure the mats are lying flat and do not get in the way of the pedals.



### IMPORTANT

**23)** Do not drive with your hand resting on the gear lever as the force exerted, even if slight, could lead over time to premature wear of the gearbox internal components.

## USING THE ROBOTISED SEQUENTIAL TRANSMISSION

(where provided)

The car can be equipped with an electronically controlled manual transmission that allows two operating modes: "MANUAL" and "AUTO".



93

AB0A0334C

With key extracted from the ignition device, the buttons on the transmission panel fig. 93 can be pressed with or without the brake pedal depressed. When the buttons are pressed, the system will not perform any activation, therefore the gear engaged before engine switching off remains engaged. With the car stationary and the key at MAR (ignition-operated electrical services on), the screen displays the engaged gear and the active operating

mode (automatic = AUTO or manual = no display).

## STARTING THE CAR

### NOTES

- ☐ On starting, the system sets itself to AUTO mode.
- ☐ Using the 1, N, R buttons with the brake pedal pressed, 1<sup>st</sup> gear, neutral (N) or reverse (R) can be engaged.
- ☐ Using the 1, N, R buttons without pressing the brake pedal, the system does not change gear.
- ☐ The levers on the steering wheel will not engage any gear, even with the brake pedal pressed.

## OPERATING MODE

The transmission/transmission can function in two operating modes:

- ☐ the first is manual (MANUAL). In this mode the driver decides directly when to shift, using the "+" fig. 94 lever on the steering wheel to shift up, or the "-" to shift down. If the request is accepted by the system, when the gear change is completed, the display shows the new gear engaged.

**NOTE** The system shows the gear actually engaged on the display and not the gear requested by the driver. If the request is not accepted by the system, the display shows the gear engaged before the request and emits an acoustic signal. If the gear change

request may adversely affect the correct operation of the engine or the transmission, the system will not allow the gear change but will automatically change down if the engine reaches the idling speed (e.g. during deceleration).

☐ the second, completely automatic (AUTO), in which the system decides when to change gear. A gear change can be requested using the control lever without having to deactivate this mode: this function, known as “gear suggestion”, suspends the automatic mode for the time necessary to select the gear requested by the driver.



To turn automatic operation (AUTO) on, press the A/M button on the gearbox panel fig. 93; when it is on, the word AUTO and the engaged gear are shown on the display. When AUTO mode is deactivated, the transmission passes to MANUAL mode.

### “Kick Down” function

The “Kick Down” function is also available: if necessary (for example when overtaking), pressing the accelerator pedal fully over the hardening point, the system downshifts one or more gears (if the rpm allows it) in order to provide suitable power and torque for the acceleration requested by the driver.

In this way the engine speed and power can be suddenly increased and then automatically restored when the conditions set previously are resumed.

**WARNING** The use of the “Kick Down” function is recommended only when overtaking or accelerating quickly, in order not to increase fuel consumption.

### LEVERS ON THE STEERING WHEEL

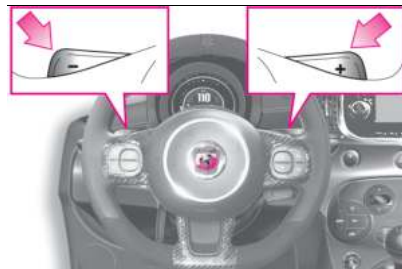

94

AB0A0385C

These enable sequential gear shifting.

☐ wheel + (pulling stalk towards driver, see fig. 95): shift up;

☐ wheel – (pulling stalk towards driver, see fig. 95): shift down.

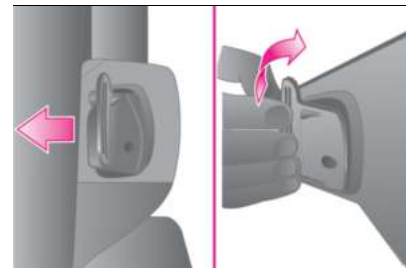

95

AB0A0386C

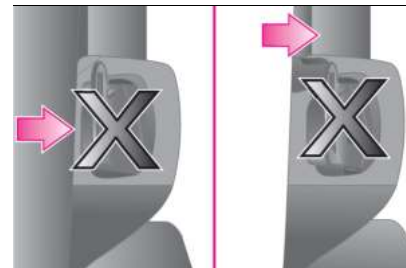

96

AB0A0387C

The engagement of a lower (or higher) gear is only permitted if the engine rpm allow it.



### STARTING THE ENGINE

To start the engine press the brake pedal: the system engages neutral (N) automatically. When the starting procedure is complete, you can hold the brake pedal down and press button (1) or the R button on the transmission

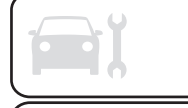

panel to engage 1<sup>st</sup> or reverse (R) gear respectively.

### Warnings

You cannot engage 1<sup>st</sup> gear by pressing the “-” shift paddle.

If starting is requested with a transmission failure, carry out the “Delayed start-up” procedure: when the key is turned to AVV for at least 7 seconds with brake pedal pressed, the engine will be started. The system will remain in recovery mode (highest permitted gear 3<sup>rd</sup>, automatic mode not available). If the engine does not start, contact an Abarth Dealership. When the driver side door is opened, the system activates the hydraulic components so that they are prepared for the subsequent engine starting.

### MOVING THE CAR

You may set off in the car in both 1<sup>st</sup> gear and 2<sup>nd</sup> gear (advisable on road surfaces with poor grip) and also in reverse gear (R). The gears can only be engaged by pressing the brake pedal.

Proceed as follows:

- ☐ press the brake pedal;
- ☐ press the button (1) on the transmission panel;
- ☐ operate the “+” shift paddle while holding down the brake pedal (only for setting off in 2<sup>nd</sup> gear);

☐ release the brake pedal and press the accelerator pedal (quickly pressing the pedal fully down and turning off the ASR, if provided, results in a “lively” departure).

### Engaging reverse gear (R)

To engage reverse gear, press the brake pedal (car completely stationary) and then press the R button on the transmission panel.

**WARNING** If the car running, the request is accepted and executed if the car speed drops below 3 km within 3 seconds from the request: if the request is not executed, the system will maintain the gear engaged or, if the speed of the car drops below 10 km/h, will put the transmission in neutral (N) and the manoeuvre will have to be repeated.

### Engaging neutral (N)

Press the (N) button to engage neutral. Neutral (N) can only be engaged with accelerator pedal released, regardless of the brake pedal status (pressed or not).

In any case, pressing the brake pedal is recommended.

When trying to engage the neutral with accelerator pedal depressed, the system will not accept the request

and maintain the speed engaged.

To engage a speed from the neutral (N) position, press the button (1) on the transmission panel (it is not necessary to press the brake pedal); the transmission will immediately choose the correct gear according to the speed of the car.

### ACOUSTIC WARNING

For safety reasons, there is a buzzer warning when parking the car with the gearbox in neutral (N) (the warning is heard when the ignition key is turned to the STOP position).

With the car stationary, the engine running and (1<sup>st</sup>), (2<sup>nd</sup>) or (R) engaged, the system activates the buzzer and automatically puts the transmission in neutral (N) when:

- ☐ the accelerator and/or brake pedal are not operated for at least 3 minutes;
- ☐ the brake pedal is pressed for longer than 10 minutes;
- ☐ the driver's door is opened and the accelerator pedal or the brake pedal are not operated for at least 1.5 seconds;
- ☐ an anomaly has been detected in the transmission.

### PARKING THE CAR

To park safely, you must engage 1<sup>st</sup> or reverse (R) gear, with your foot on the brake pedal and, if there is a gradient,

operate the handbrake. Wait until the indication of the gear engaged disappears on the display before releasing the brake pedal.

**WARNING NEVER** leave the car with the gearbox in neutral (N).

## GENERAL WARNINGS

- ▣ With car stationary and gear engaged, always keep the brake pedal pressed until you decide to set off, then release the brake and accelerate gradually.
- ▣ During prolonged stops with the engine running, it is advisable to keep the transmission in neutral (N).
- ▣ In order to safeguard the efficiency of the clutch, do not use the accelerator to keep the car stationary (e.g. when stopped on an incline); if the clutch overheats it could be damaged. Use the brake pedal or the handbrake instead and use the accelerator pedal only when you decide to set off.
- ▣ Only use 2<sup>nd</sup> gear when you need greater control for setting off on surfaces with poor grip.
- ▣ If you have to engage 1<sup>st</sup> gear with reverse gear (R) engaged, or vice versa, only do so when the car is completely stationary and with the brake pedal pressed.

▣ Although it is strongly inadvisable, if you are driving downhill and, for unexpected reasons, you let the car move forward with the transmission in neutral (N), when there is a request to engage a gear, depending on the actual speed of the car, the system will automatically engage the best gear for the correct transmission of drive torque to the wheels.

▣ When necessary, you can engage 1<sup>st</sup> gear, reverse (R) or neutral (N) with the engine off, the key at AVV and the brake pressed. In this case, it is advisable to change allowing at least 5 seconds to elapse between one gear change and the next to safeguard the operation of the hydraulic system and the pump in particular.

▣ Fully and quickly depressing the accelerator pedal activates a function that allows a "lively" departure.

▣ For starting uphill, accelerating gradually but fully immediately after having released the handbrake or the brake pedal allows the engine to greatly increase the rpm and tackle the steepest gradients with more torque to the wheels.



## IMPORTANT

**24)** Using the levers incorrectly (levers pushed towards the dashboard) could break them.

**25)** Using the levers incorrectly (levers pushed towards the dashboard, see fig. 96) could break them.

## DUALDRIVE ELECTRIC POWER STEERING

### OPERATION

This only operates with the ignition key turned to MAR and engine running . Electric power steering allows the force required at the steering wheel to be adapted to the driving conditions.

**WARNING** When turning the ignition key quickly, full power steering functionality can be achieved after a few seconds.

When the SPORT function is turned on (see "Controls" paragraph in this chapter) the electric power steering assistance is altered, increasing the sensitivity of the steering wheel

**WARNING** During parking manoeuvres requiring a lot of steering, the steering



may become harder: this is normal and is due to the intervention of the system to protect the electric steering motor from overheating, so no repair is required. When the car is used again later on, the power steering will work normally.

 122) 123)



### WARNING

**122)** *It is absolutely forbidden to carry out any after-market operation involving steering system or steering column modifications (e.g.: installation of anti-theft device) that could badly affect performance and safety, invalidate the warranty and also result in non-compliance of the car with type-approval requirements.*

**123)** *Before performing any maintenance operations, always turn off the engine and remove the key from the ignition to lock the steering column (especially when the car wheels are not touching the ground). If this is not possible (for example if the key needs to be turned to MAR or the engine must be running), remove the main fuse that protects the electric power steering.*

## SPORT FUNCTION

When the SPORT button (1) fig. 97 is pressed the sports driving setting is turned on featuring more responsiveness during acceleration, an increase in drive torque and more precise steering with greater effort required on the steering wheel.



97

AB0A0442

When this function is on, the word SPORT (1) fig. 98 is lit up in the display and the instrument panel shows a dedicated screen.

Press the button again to turn the function off and restore the normal driving setting.

**WARNING** If the engine is switched off in SPORT or NORMAL mode, the system will set to NORMAL mode the next time the engine is started.

**WARNING** When the SPORT button is pressed, the function is activated about 5 seconds later.



98

AB0A0360C

**WARNING** During acceleration, when the SPORT function is used, the steering may shudder, which is typical of a sports setting.

**NOTE** For vehicles equipped with an Akrapovic exhaust system, a considerable increase in engine sound can be heard when the SPORT mode is activated. This is caused by opening the valve located in the Akrapovic exhaust, which improves performance.

## **PARKING SENSORS**

(where provided)

Parking sensors are located in the rear bumper to detect and inform the driver, through an acoustic and visual warning, of the presence of obstacles at the rear part of the car. The sound may be intermittent or continuous depending on the distance from the obstacle.



99

AB0A0288C

### **ACTIVATION**

The sensors are automatically activated when reverse gear is engaged. The acoustic warning becomes more frequent as the obstacle behind the car gets closer.

### **ACOUSTIC WARNING**

When reverse gear is engaged and there is an obstacle behind the car an acoustic warning is activated and the warning varies as the distance of the obstacle from the bumper varies. The frequency of the acoustic warning:

- ▣ increases as the distance between the car and the obstacle decreases;
- ▣ becomes continuous when the distance between the car and the obstacle is less than 30 cm and stops if the distance increases;
- ▣ is constant if the distance between the car and the obstacle is unchanged.

### **Detection distances**

If several obstacles are detected by the sensors, only the nearest one is considered.

### **INDICATIONS ON DISPLAY**

When the sensors are activated, the screen in fig. 100 appears on the display.



100

AB0A0390C

In addition to the acoustic warning, information about the presence and distance from the obstacle is given visually on the instrument panel display. The coloured arcs at the rear of the

car indicate that an obstacle has been detected. The system indicates a detected obstacle by displaying an arc according to the distance of the obstacle and its position in relation to the car. If an object is detected to the rear of the car (to the side or at the centre), the display shows a flashing arc in the corresponding zone and an intermittent sound is emitted. As the car approaches the object, the display shows one or more flashing arcs that approach the car, and the sound becomes more frequent until it becomes continuous. The colour on the display depends on the distance from and position of the obstacle. As the distance between the car and obstacle decreases, the arcs change from yellow to flashing red (to the right, at the centre or to the left).

### **FAULT INDICATIONS**

Parking sensor failures, if any, will be indicated when reverse is engaged by the switching on of the **P** symbol on the instrument panel together with the message on the display (see "Warning lights and messages" paragraph).

### **OPERATION WITH A TRAILER**

The operation of the sensors is automatically deactivated when the trailer electric cable plug is inserted in the tow hook socket of the car. The

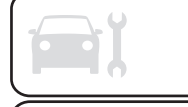

sensors are automatically reactivated when the trailer's cable plug is removed.

## GENERAL WARNINGS

When parking, take the utmost care over obstacles that may be above or under the sensor.



124)



26) 27)

Objects close to the car are not detected under certain circumstances and could therefore cause damage to the car or be damaged.

Some conditions may influence the performance of the parking system:

▣ Reduced sensor sensitivity and a reduction in the parking assistance system performance could be due to the presence on the surface of the sensor of: ice, snow, mud, thick paint.

▣ The sensor may detect a non-existent obstacle (echo interference) due to mechanical interference, for example when washing the car, in rain (strong wind), hail.

▣ The warnings sent by the sensor can also be altered by the presence of ultrasonic systems (e.g. pneumatic brakes of trucks or pneumatic drills) near the car.

▣ Parking assistance system performance can also be influenced by the position of the sensors, for

example due to a change in the ride setting (caused by wear to the shock absorbers, suspension), or by changing tyres, overloading the car or carrying out specific tuning operations that require the car to be lowered.

▣ The presence of a tow hook without trailer interferes with the correct operation of the parking sensors. If a fixed tow hook is installed, the parking sensors cannot be used. If the driver wishes to install a removable tow hook, it should be disconnected from the crossmember whenever the trailer is not attached to prevent the activation of the sensors.

▣ Do not apply stickers to the sensors.



## WARNING

**124)** *The driver is always responsible for parking and other dangerous manoeuvres. While carrying out these manoeuvres, always make sure that no people (especially children) or animals are in the area concerned. The parking sensors are used to assist the driver, who must never allow his attention to lapse during potentially dangerous manoeuvres, even those executed at low speeds.*



## IMPORTANT

**26)** *The sensors must be clean of mud, dirt, snow or ice in order for the system to operate correctly. Be careful not to scratch or damage the sensors while cleaning them. Avoid using dry, rough or hard cloths. The sensors should be washed using clean water with the addition of car shampoo if necessary. When using special washing equipment such as high pressure jets or steam cleaning, clean the sensors very quickly keeping the jet more than 10 cm away.*

**27)** *Have interventions on the bumper in the area of the sensors carried out only by an Abarth Dealership. Interventions on the bumper that are not carried out properly may compromise the operation of the parking sensors.*

## REFUELLING THE CAR

Stop the engine before refuelling. Only refuel with unleaded petrol with octane rating (RON) not less than 95, in compliance with the European specification EN228.

**WARNING** An inefficient catalytic converter leads to harmful exhaust emissions, thus contributing to air pollution.

**WARNING** Never introduce leaded petrol to the tank, even in small amounts in an emergency, as this would damage the catalytic converter beyond repair.

## REFUELLING CAPACITY

To ensure that you fill the tank completely, top up twice after the first click of the fuel supply gun. Further top-ups could cause faults in the fuel feeding system.

## FUEL TANK CAP

Cap (2) fig. 101 is fitted with a cable that secures it to flap (1) so that it cannot be lost.



101

AB0A0058C

Unscrew cap (2) using the ignition key. The sealing may cause a slight pressure increase in the tank. A little breathing off, while slackening the cap is absolutely normal. When refuelling, fasten the plug to the device inside the flap as shown in fig. 101.



## Fuels - identification of vehicle compatibility. Graphic symbol for consumer information in accordance with EN16942

The symbols shown below facilitated recognizing the correct fuel type to be used on your car.

Before proceeding with refuelling, check the symbols inside the fuel filler flap (where provided) and compare them with the symbols shown on the fuel pump (where provided).

## Symbols for petrol powered cars



**E5:** Unleaded petrol containing up to 2.7% (m/m) oxygen and with maximum 5.0% (V/V) ethanol compliant with EN228.

**E10:** Unleaded petrol containing up to 3.7% (m/m) oxygen and with maximum 10.0% (V/V) ethanol compliant with EN228.



## WARNING

**125)** Do not approach naked flames or lit cigarettes to the fuel tank filler: fire risk. Keep your face away from the fuel filler to prevent breathing in harmful vapours.

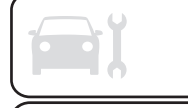

## SAVING FUEL

### GENERAL INFORMATION

#### Car maintenance

Checks and adjustments should be carried out in accordance with the "Service Schedule" (see chapter "Maintenance and care").

#### Tyres

Check the tyre pressures at least once every four weeks: if the pressure is too low, consumption levels increase as resistance to rolling is higher.

#### Unnecessary loads

Do not travel with an overloaded luggage compartment. The weight of the vehicle and its arrangement greatly affect fuel consumption and stability. When transporting particularly large objects, use a trailer if possible.

#### Roof rack/ ski rack

Remove the roof rack or the ski rack from the roof after use. These accessories lower aerodynamic penetration and adversely affect consumption levels.

#### Electric devices

Use electrical devices only for the amount of time needed. The heated rear window, additional headlights, screen wipers and heater fan require a considerable amount of energy; increasing the current uptake increases

fuel consumption (by up to +25% in an urban cycle).

#### Climate control system

Using the climate control system will increase consumption: use the air vents when the temperature outside permits.

#### Devices for aerodynamic control

The use of non-certified devices for aerodynamic control may adversely affect air drag and consumption levels.

### DRIVING STYLE

#### Start

Do not warm up the engine at low or high revs when the car is stationary; this causes the engine to warm up more slowly, thereby increasing fuel consumption and emissions. It is therefore advisable to move off immediately, slowly, avoiding high speeds: in this way the engine will warm up more quickly.

#### Unnecessary actions

Avoid accelerating when stopped at traffic lights or before switching off the engine. The latter action, as well as double-declutching, is unnecessary and causes increased fuel consumption and pollution.

#### Gear selection

Use a high gear when traffic and road conditions allow it. Using a low gear

for faster acceleration will increase fuel consumption. In the same way improper use of a high gear increases consumption, emissions and engine wear.

#### Top speed

Fuel consumption considerably increases as speed increases. Maintain a constant speed, avoiding unnecessary braking and acceleration, which cost in terms of both fuel consumption and emissions.

#### Acceleration

Accelerating violently severely affects consumption and emissions: acceleration should be gradual and should not exceed the maximum torque.

### CONDITIONS OF USE

#### Cold starting

Short journeys and frequent cold starts do not allow the engine to reach optimum operating temperature. Consequently, both consumption (from +15 to +30% on the urban cycle) and emissions will increase.

#### Traffic and road conditions

High fuel consumption is caused by heavy traffic, for instance when travelling in a queue with frequent use of low gears or in cities with many traffic lights. Winding mountain roads

and rough road surfaces also adversely affect consumption.

### **Stops in traffic**

During prolonged hold-ups (e.g. level crossings) switch off the engine.



## IN AN EMERGENCY

*Have a flat tyre or a burnt-out bulb?  
At times, a problem such as these may  
interfere with your driving experience.  
The pages on emergencies can help  
you to deal with critical situations  
independently and calmly.  
In an emergency, we recommend that  
you call the phone number found in the  
Warranty Booklet.  
It is also possible to call the 00 800  
3428 0000 freephone number to  
search the nearest Abarth Authorised  
Dealership.*

HAZARD WARNING LIGHTS .....	107
REPLACING A BULB .....	107
REPLACING AN EXTERIOR BULB .....	110
REPLACING INTERIOR BULBS ....	113
FUSE REPLACEMENT .....	114
Fix&Go KIT .....	120
EMERGENCY STARTING .....	122
FUEL CUT-OFF SYSTEM .....	123
TOWING THE CAR.....	123

## HAZARD WARNING LIGHTS

These lights are switched on by pressing button (1) fig. 102, regardless of the position of the ignition key.

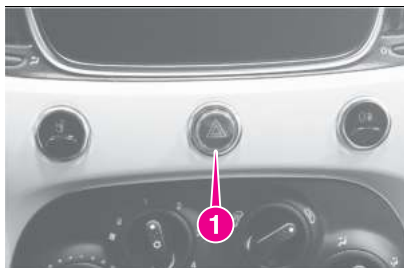

102

AB0A0474

With the device on, warning lights ← and → light up in the instrument panel. Press the button (1) again to switch the lights off.

**WARNING** The use of hazard warning lights is governed by the highway code of the country you are driving in: comply with legal requirements.

### Emergency braking

In the event of an emergency braking, the hazard warning lights switch on automatically together with warning lights ← and → on the instrument panel.

The lights switch off automatically when emergency braking ceases.

## REPLACING A BULB

### GENERAL INSTRUCTIONS

- ☐ Before replacing a bulb check the contacts for oxidation;
- ☐ burnt bulbs must be replaced by others of the same type and power;
- ☐ always check the headlight beam direction after changing a bulb;
- ☐ when a light is not working, check that the corresponding fuse is intact before replacing a bulb. For the location of fuses, refer to the paragraph "Replacing fuses" in this chapter.

 126) 127) 128) 129)

 28) 29)

**WARNING** When the weather is cold or damp or after heavy rain or washing, the surface of headlights or rear lights may steam up and/or form drops of condensation on the inside. This is a natural phenomenon due to the difference in temperature and humidity between the inside and the outside of the glass which does not indicate a fault and does not compromise the normal operation of lighting devices. The mist disappears quickly when the lights are turned on, starting from

the centre of the diffuser, extending progressively towards the edges.



## BULB TYPES

Various types of bulbs are fitted to your car:

**All-glass bulb:** (type A) these are pressure fitted - pull to remove.

---

**Bayonet bulb:** (type B) to remove them press the bulb and turn it anticlockwise.

---

**Cylindrical bulbs:** (type C) release them from their contacts to remove.

---

**Halogen bulbs:** (type D) release the fastening clip from its housing to remove the bulb.

---

**Halogen bulbs:** (type E) release the fastening clip from its housing to remove the bulb.

---

**Xenon gas discharge bulbs:** (type F) contact an Abarth Dealership for replacement.

---

A



B



C



D



E



## Light bulbs

Use	Type	Power	Ref. Figure
Main beams	H7	55W	D
Dipped headlights	H7	55W	D
Xenon gas discharge dipped beam headlights (where present)	D1S	35W	F
Front side lights / daytime running lights	LED/W21W	21W	A
Front direction indicators	PY24W	24W	B
Side direction indicators	W5W	5W	A
Rear direction indicators	PY21W	21W	B
Tail/brake light	P21 / 5W	5/21W	B
Reverse gear	W16W	16W	B
Rear fog light	W16W	16W	B
Centre ceiling light	C5W	5W	C
Passenger side ceiling light	C5W	5W	C
Boot light	W5W	5W	A
Number plate light	C5W	5W	C
Fog lights	H1/H11(*)	55W	E
Third brake lights	W5W	5W	A

(\*) For versions/markets where provided





**WARNING**

**126)** Modifications or repairs to the electric system that are not carried out properly or do not take the system technical specifications into account can cause malfunctions leading to the risk of fire.

**127)** Halogen bulbs contain pressurised gas, in the case of breakage they may burst causing glass fragments to be projected outwards.

**128)** Before replacing the bulb, wait for the exhaust ducts to cool down: **DANGER OF SCALDING!**

**129)** Only replace the light bulbs when the engine is off and in a position that does not interfere with traffic and lets you safely replace them (see the description in the "Replacement" paragraph). Also ensure that the engine is cold, to prevent the risk of burns.



**IMPORTANT**

**28)** Halogen bulbs must be handled holding the metallic part only. Touching the transparent part of the bulb with your fingers may reduce the intensity of the emitted light and even reduce the lifespan of the bulb. In the event of accidental contact, wipe the bulb with a cloth moistened with alcohol and let the bulb dry.

**29)** Where possible, it is advisable to have bulbs changed at an Abarth Dealership. The correct operation and direction of the external lights are absolutely essential for

*the safety of the car and of compliance with the law.*

**REPLACING AN EXTERIOR BULB**

For the type of bulb and power rating, see paragraph "Replacing a bulb".

**FRONT LIGHT CLUSTERS**

The front light clusters contain side/tail lights, dipped headlights, main beam headlights and direction indicator bulbs.

**Access to the direction indicator bulbs**

Working from the engine compartment, remove the rubber cap (1) fig. 103.

**Access to the main beam headlight bulbs**

Rotate the cap (2) fig. 103 anticlockwise.

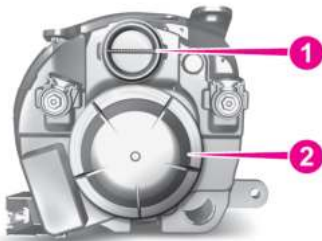

103

AB0A0309C

**DIRECTION INDICATORS**

**Front**

To replace the bulb, proceed as follows:

- ▣ turn the protection cap (1) fig. 103 anticlockwise and remove it;
- ▣ turn the bulb holder (1) fig. 104 anticlockwise and extract it;
- ▣ remove the pressure-fitted bulb and replace it;
- ▣ refit the bulb holder (1) by turning it clockwise and making sure that it locks correctly;
- ▣ insert the protection cap and turn it clockwise.

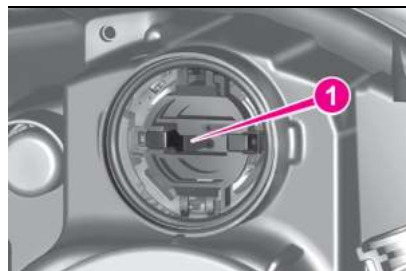

104

AB0A0361C

**Side**

**WARNING** The intervention must be carried out taking all precautions necessary to avoid damaging the bodywork (please use a sufficiently rigid and appropriately thick plastic card).

To replace the bulb, proceed as follows:

▣ apply leverage in the point shown by the arrows (1) and (2) to compress the fixing springs and extract the light fig. 105;

▣ turn the bulb holder anticlockwise, extract the press-fitted bulb and replace it;



105

AB0A0310C

▣ refit the bulb holder in the lens, then position the light, ensuring that the fastening clip clicks into place.

### DIPPED BEAM HEADLIGHTS

To replace the bulb, proceed as follows:

▣ turn the protection cap (2) fig. 103 anticlockwise and remove it;

▣ disconnect the connector (1) fig. 106 and release the bulb holder;

▣ extract the bulb and replace it;

▣ refit the bulb in its housing and reconnect the connector;

▣ refit the protection cap in its housing and turn clockwise.

 130)

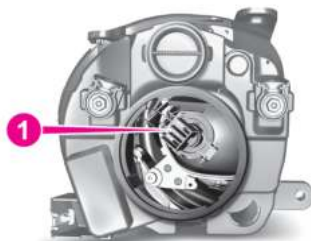

106

AB0A0311C

### MAIN BEAM HEADLIGHTS

To replace the bulb, proceed as follows:

▣ steer the wheel fully inwards, undo the screws (1) fig. 107 and move the inner wheel arch plastic cover (2) aside to access the bulb;

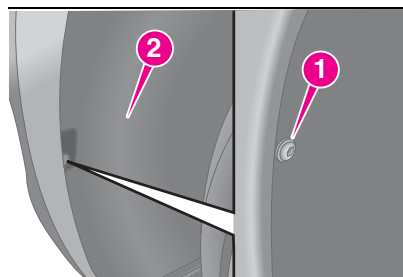

107

AB0A0471

▣ remove the rubber cap on the bulb holder;

▣ release the two bulb holding clips (1) fig. 108;

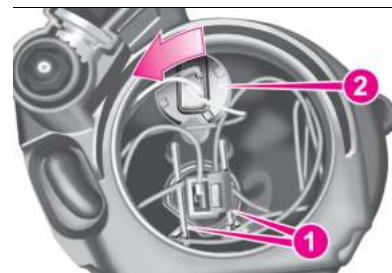

108

AB0A0083C

▣ extract the bulb and replace it;

▣ fit the new bulb, making the outline of the metallic part coincide with the grooves on the reflector, then reattach the bulb holding clips;

▣ refit the rubber cap;

▣ refit the inner cover on the wheel arch and tighten the screws.

### SIDE LIGHTS/DAYTIME RUNNING LIGHTS

To replace the bulb, proceed as follows:

▣ steer the wheel fully inwards, undo the screws (1) fig. 107 and move the inner wheel arch plastic cover (2) aside to access the bulb;

▣ remove the rubber cap on the bulb holder;



- ▣ turn the bulb holder (2) fig. 108 anticlockwise and extract it;
- ▣ remove the pressure-fitted bulb and replace it;
- ▣ refit the bulb holder (2) by turning it clockwise and making sure that it locks correctly;
- ▣ refit the rubber cap;
- ▣ refit the inner cover on the wheel arch and tighten the screws.

### FOG LIGHTS

(where provided)

For replacing these bulbs, contact an Abarth Dealership.

### REAR LIGHT CLUSTERS

To replace the bulb proceed as follows:

- ▣ open the tailgate;
- ▣ unscrew the two fastening screws (1) fig. 109 and extract the light cluster axially without rotating it;
- ▣ remove the bulb holder from its housing releasing it from the locking tabs (2);
- ▣ extract the bulbs by pushing them slightly and turning them anticlockwise.

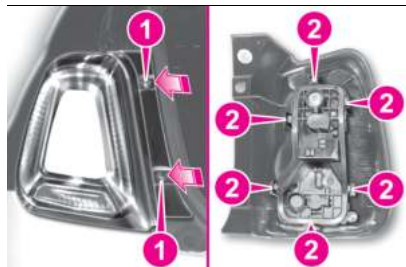

109

AB0A0313C

The bulbs are arranged as follows fig. 110:

- 1: side / brake light;
- 2: direction indicators.

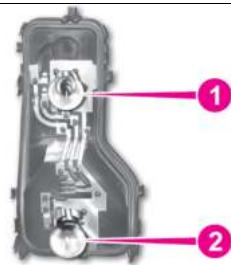

110

AB0A0314C

### REVERSING LIGHT/REAR FOG LIGHT

For bulb replacement, contact an Abarth Dealership.

### THIRD BRAKE LIGHTS

To replace the bulb proceed as follows:

- ▣ remove the two guard caps and

unscrew the two fastening screws (1) fig. 111;



111

AB0A0097C

- ▣ remove the assembly;
- ▣ disconnect the electrical connector (2) fig. 112;
- ▣ press the retaining device (3) fig. 112 and open the bulb holder;

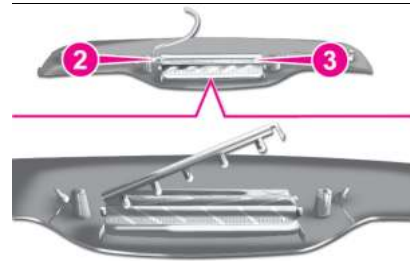

112

AB0A0098C

- ▣ remove the press-fitted bulb to be replaced and replace it;

- ☐ close the bulb holder making sure the retaining device is correctly locked;
- ☐ screw in the two fastening screws and reinstall the guard caps.

## NUMBER PLATE LIGHTS

To replace the bulbs, proceed as follows:

- ☐ operate in the point shown by the arrow fig. 113 and remove the lens;
- ☐ change the bulb, releasing it from the side contacts;
- ☐ fit the new bulb and make sure that it is correctly clamped between the contacts;

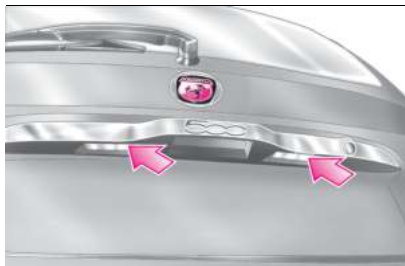

113

AB0A0099C

- ☐ then refit the lens.



### WARNING

**130)** Due to the high power supply voltage, gas discharge bulbs (Xenon) should only be replaced by specialised

*technicians: danger of death! Contact an Abarth Dealership.*

## REPLACING INTERIOR BULBS

For the type of bulb and power rating, see paragraph "Replacing a bulb".

### INTERIOR CEILING LIGHT

To replace the bulb, proceed as follows:

- ☐ using the screwdriver provided, extract the ceiling light (1) fig. 114 working in the point shown by the arrow;

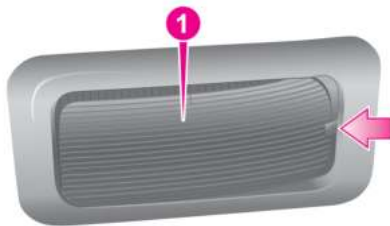

114

AB0A0100C

- ☐ open cover (2) fig. 115 as shown and then change bulb (3) fig. 116 it from the side contacts;
- ☐ insert the new bulb and make sure that it is correctly clamped between the contacts;

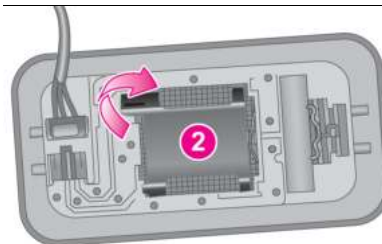

115

AB0A0101C

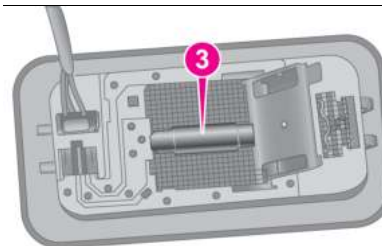

116

AB0A0102C

- ☐ close the cover (2) then refit the lens (1).

### BOOT COURTESY LIGHT

To replace the bulb, proceed as follows:

- ☐ open the boot;
- ☐ using the screwdriver provided, extract the ceiling light (1) fig. 117 working in the point shown by the arrow;



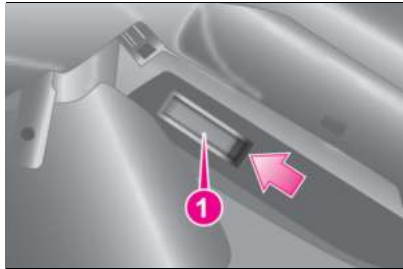

117

AB0A0103C

- ☐ open the protection (2) fig. 118
- ☐ replace the snap-fitted bulb (3) fig. 118;

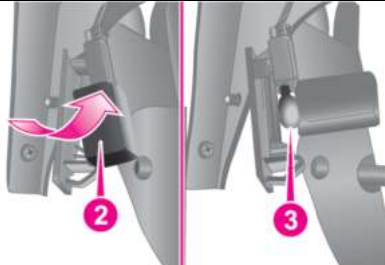

118

AB0A0104C

- ☐ close the cover (2) on the lens;
- ☐ then refit the ceiling light by inserting it correctly in its housing, on one side and then pressing on the other side until it clicks into place.

## FUSE REPLACEMENT

Contact an Abarth Dealership to have a fuse replaced.

### GENERAL INFORMATION

Fuses protect the electrical system: they intervene (blow) in the event of a failure or improper action on the system.

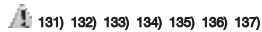

Check the state of the corresponding fuse when a device does not work: the filament (1) fig. 119 should be intact. If it is not, replace the blown fuse with another with the same ampere rating (same colour).

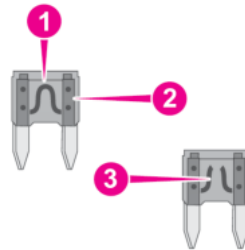

119

AB0A0105C

- 2 = intact fuse;
- 3 = fuse with damaged filament.

To facilitate fuse replacement, use the pliers hooked inside the fuse box lid on the dashboard left-hand side.

Refer to the tables on the following pages to identify the protective fuse.

### FUSE LOCATION

#### Dashboard fusebox

To access the fuse you must remove the press-fit cover (5) fig. 120.

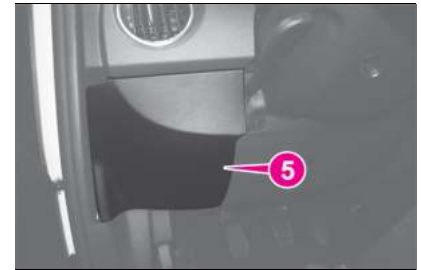

120

AB0A0291C

The 5A fuse for door mirror demisting is located in the diagnosis socket area, as shown in fig. 121.

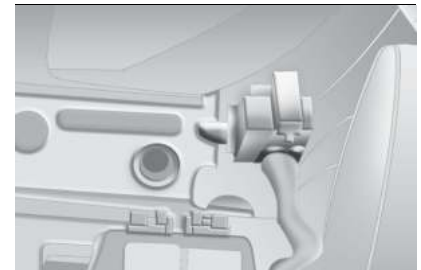

121

AB0A0317C

The fuse box shown in fig. 123 fig. 98 is located in the lower area next to the pedal unit.

## Engine compartment fusebox

The fuse box is located on the right side of the engine compartment, next to the battery.

To access the fuses, proceed as follows:

- ☐ Fully press screw (1) fig. 122;
- ☐ at the same time slowly rotate the screw anticlockwise, until resistance is encountered (do not overtighten);
- ☐ slowly release the screw;
- ☐ opening is indicated by the entire screw head coming out of its housing;

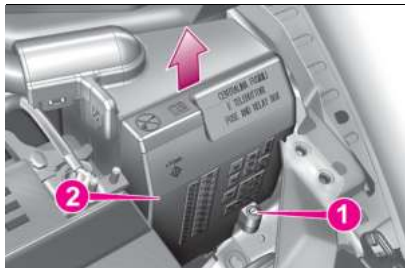

122

AB0A0375C

- ☐ remove cover (2), sliding it upwards on the side guides, as indicated in the figure.

- ☐ after replacing the fuse, refit the cover, making sure that it is closed properly.

The number identifying the electrical component corresponding to each fuse is on the cover fig. 124.



## WARNING

**131)** Contact an Abarth Dealership to have a fuse replaced.

**132)** If the fuse blows again, contact an Abarth Dealership.

**133)** Never replace a faulty fuse with metal wires or anything else.

**134)** Never replace a fuse with another with a higher amp rating; **RISK OF FIRE.**

**135)** If a general protection fuse (MEGA-FUSE, MIDI-FUSE, MAXI-FUSE) blows, contact an Abarth Dealership.

**136)** Before replacing a fuse, make sure that the ignition key has been removed and that all the other services are switched off and/or disengaged.

**137)** If a general protection fuse for the safety systems (airbag system, braking system), power unit systems (engine system, transmission system) or driving system blows, contact an Abarth Dealership.



## IMPORTANT

**30)** If you need to wash the engine compartment, take care not to directly hit the engine compartment fusebox with the water jet.



**DASHBOARD FUSEBOX**



123

AB0A0106C

PROTECTED DEVICE	FUSE	AMPERE
Headlight alignment corrector	F13	5 (*)
Diagnosis socket, Uconnect, climate control, EOBD	F36	15
Brake light switch, instrument panel node	F37	5
Central door locking	F38	15
Windscreen/rear window washer pump	F43	15
Driver side electric window	F47	20

PROTECTED DEVICE	FUSE	AMPERE
Passenger side electric window	F48	20
Parking sensor, controls backlighting	F49	5
Climate control, brake lights, clutch, electric sunroof, electric mirrors	F51	7.5
Instrument panel node	F53	5

(\*) (where provided)



## ENGINE COMPARTMENT FUSEBOX

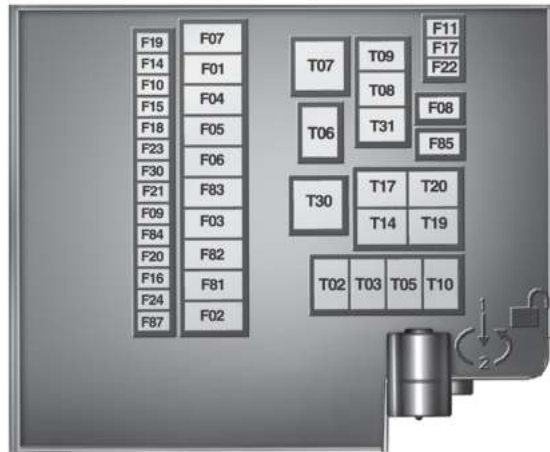

124

AB0A0319C

PROTECTED DEVICE	FUSE	AMPERE
HI-FI	F02	20
Climate control electric fan	F08	30
Headlight washers	F09	30
Horns	F10	10
Main-beam headlights	F14	10/15(*)
Electric roof motor	F15	20

PROTECTED DEVICE	FUSE	AMPERE
Robotised sequential transmission control unit power supply (+ ignition)	F16	7.5
Heated rear window	F20	30
Fog lights	F30	15
Robotised sequential transmission control unit	F84	10
Front power socket (with or without cigar lighter)	F85	20

(\*) Only for versions equipped with Xenon gas discharge lamps



## Fix&Go KIT

(for versions/markets, where provided)  
The Fix&Go quick tyre repair kit is located in the boot inside a dedicated container.

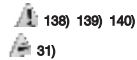

## TYRE REPAIR PROCEDURE

### Preliminary operations:

- ▣ Stop the car in a position that is not dangerous for oncoming traffic where you can change the wheel safely. The ground must be flat and sufficiently compact;
- ▣ stop the engine and engage the parking brake;
- ▣ engage 1<sup>st</sup> gear if the car is uphill, or reverse if the car downhill;
- ▣ steer the wheels completely;
- ▣ in the event of a steep slope, place a wedge or stone behind the wheels;
- ▣ Wear the reflective safety jacket (compulsory by law) before getting out of the car. In any case, follow the road safety laws in force in the country where you are driving;
- ▣ wear the gloves.

### Tyre repair:

Remove the adhesive speed label (3) fig. 125 and fig. 128 and apply it in a clearly visible position on the dashboard.

## OPT1 kit

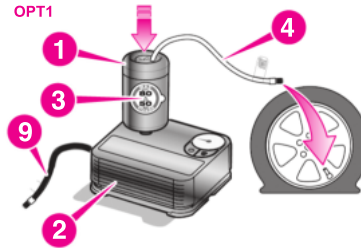

125

AB0A0477

- ▣ remove the cap from the tyre valve and connect and screw the transparent tube of the sealant (4) fig. 125 onto the valve. If a 250 ml cartridge is present the housing of the transparent tube is provided with removable ring to facilitate extraction. Make sure that the ON/OFF button (5) fig. 126 is in the off position (button not pressed);

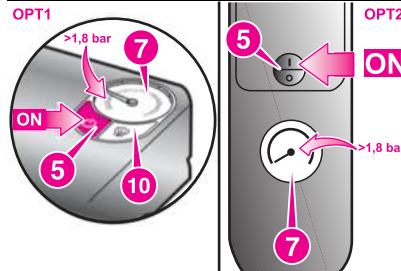

126

AB0A0478

- ▣ plug the electrical connector of the tyre inflation kit into the 12V socket of the car and start the engine;
- ▣ operate the compressor by pressing the ON/OFF button (5) fig. 126. When the pressure gauge (7) indicates the prescribed pressure indicated in the "Wheels" chapter in this Owner Handbook or on the label, switch off the compressor by pressing the button again and in any case do not disconnect the hose until the sealing liquid has been blown in (about 2 minutes);
- ▣ If the pressure gauge (7) fig. 126 reads a pressure lower than 1.8 bar / 26 psi 15 min. after turning on the compressor, switch off the compressor, disconnect the sealant hose (4) fig. 125 from the tyre valve proceed with the procedure for restoring pressure after repair described in the following paragraph after having disconnected the cartridge. Disconnect the cartridge (1) from the compressor, by pressing the release button (8) and lifting the cartridge (1) upwards fig. 127.

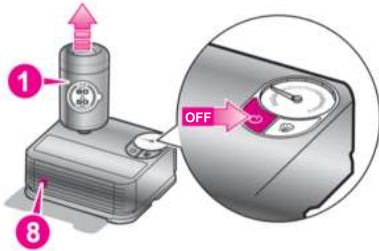

127

AB0A0479

## OPT2 kit



128

AB0A0480

**Use only in the event of a puncture. Do not use to inflate tyre that is not punctured.**

☐ remove the cap from the tyre valve and connect and screw the transparent tube of the sealant (4) fig. 128 onto the valve. Make sure that the ON/OFF button (5) fig. 126 is in the off position (button not pressed);

☐ plug the electrical connector of the tyre inflation kit into the 12V socket of the car and start the engine;

☐ operate the compressor by pressing the ON/OFF button (5) fig. 126. When the pressure gauge (7) indicates the prescribed pressure indicated in the "Wheels" chapter in this Owner Handbook or on the label, switch off the compressor by pressing the button again and in any case do not disconnect the hose until the sealing liquid has been blown in (about 2 minutes);

☐ If the pressure gauge (7) fig. 126 reads a pressure lower than 1.8 bar / 26 psi 15 min. after turning on the compressor, switch off the compressor, disconnect the sealant hose (4) fig. 128 from the tyre valve proceed with the procedure for restoring pressure after repair described in the following paragraph.

### Procedure for restoring pressure after repair

☐ Move the car by approximately 10 m to allow the distribution of the sealant;

☐ secure the car following the instructions described in the "Preliminary operations" paragraph in this chapter;

☐ restore the pressure using the black inflation tube (9) fig. 125 for the **OPT1** version or the inflation tube (4)

fig. 128 for the **OPT2** version until the prescribed pressure is reached. If also in this case, the pressure is lower than 1.8 bar / 26 psi 15 minutes after turning on, do not resume driving but contact an Abarth Dealership.

Only for **OPT1**: Press the air release button to adjust any tyre overpressure (10) fig. 126.

After driving for approximately 8 km / 5 miles, repeat the procedure for restoring the pressure.

For **OPT2** only: This can only be used to restore pressure after using the kit to repair a puncture (i.e. with empty sealing cartridge)



### WARNING

**138)** The information required by the applicable regulation is indicated on the Fix&Go kit package label. Carefully read the label on the cartridge before use, avoid improper use. The kit should be used by adults and cannot be used by children.

**139) IMPORTANT:** Do not exceed 80 km/h. Avoid sudden acceleration or braking. The kit provides a temporary repair, therefore the tyre must be examined and repaired by a specialist as soon as possible. Before using the kit, ensure that the tyre is not excessively damaged and that the rim is in good condition, otherwise do not use it and call roadside assistance. Do not remove



foreign bodies from the tyre. Do not let the compressor turned on for more than 20 consecutive minutes - overheating hazard.  
**140)** The compressor in the kit **MAY NOT BE USED** for purposes other than tyre repair.



### IMPORTANT

**31)** The sealant fluid is effective with external temperatures from  $-40^{\circ}\text{C}$  to  $+50^{\circ}\text{C}$ . The sealant fluid has an expiry date and must be replaced periodically. It is possible to repair tyres with damage on the tread up to a maximum diameter of 6 mm. Show the cartridge and the label to the personnel who must handle the tyre treated with the TireKit.

## EMERGENCY STARTING

If the  symbol on the display turns on constantly, contact an Abarth Dealership immediately.

### JUMP STARTING

If the battery is flat, the engine may be started using an auxiliary battery fig. 129 with the same capacity or a little higher than the flat one.

 32)

 141)

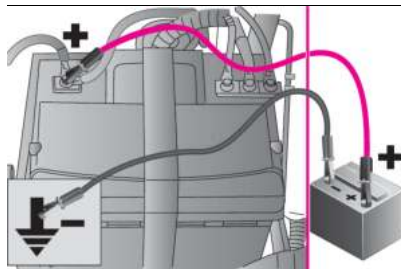

129

AB0A0078C

Proceed as follows to start the car:

- ☐ connect the positive terminals (+ mark near the terminal) of the two batteries using a suitable lead;
- ☐ with a second lead, connect the negative terminal (-) of the auxiliary battery to an earth point  on the engine or the gearbox of the car to be started;
- ☐ start the engine;
- ☐ when the engine has been started, remove the leads reversing the order above.

If after a few attempts the engine does not start, do not persist but contact an Abarth Dealership.

**WARNING** Do not directly connect the negative terminals of the two batteries: sparks could ignite explosive gas released from the battery. If the auxiliary battery is installed on another

car, prevent accidental contact between metallic parts of the two cars.

### BUMP STARTING

Never bump start the engine by pushing, towing or driving downhill. This could cause fuel to flow into the catalytic converter and damage it beyond repair.

**WARNING** Remember that the brake servo and electric power steering are not active until the engine is started. A much greater effort will therefore be required to use the brake pedal or turn the steering wheel.



### WARNING

**141)** This starting procedure must be performed by expert personnel because incorrect actions could cause electrical discharge of considerable intensity. Furthermore, battery fluid is poisonous and corrosive: avoid contact with skin and eyes. Keep naked flames and lighted cigarettes away from the battery and do not cause sparks.



## IMPORTANT

**32)** *Never use a fast battery charger to start the engine as this could damage the electronic systems, particularly the engine ignition and fuel supply control units.*

## FUEL CUT-OFF SYSTEM

This intervenes in the case of an impact causing:

- ☐ the interruption of the fuel supply with the engine consequently cutting out
  - ☐ the automatic unlocking of the doors;
  - ☐ turning on the lights inside the car.
- The intervention of the system is indicated by a message shown on the display.

**WARNING** Carefully check the car for fuel leaks, for instance in the engine compartment, under the car or near the tank area.



After a crash, turn the ignition key to STOP position to prevent the battery from running down.

To restore the correct operation of the car, proceed as follows:

- ☐ turn the ignition key to the MAR position;
- ☐ activate the right direction indicator;
- ☐ deactivate the right direction indicator;
- ☐ activate the left direction indicator;
- ☐ deactivate the left direction indicator;
- ☐ activate the right direction indicator;
- ☐ deactivate the right direction indicator;
- ☐ activate the left direction indicator;
- ☐ deactivate the left direction indicator;
- ☐ ignition key turned to the OFF position;
- ☐ turn the ignition key to the MAR-ON position.



## WARNING

**142)** *If, after an impact, you smell fuel or notice leaks from the fuel system, do not reactivate the system to avoid the risk of fire.*

## TOWING THE CAR

The tow ring provided with the car is housed in the tool bag under the boot mat.



## ATTACHING THE TOW RING

Proceed as follows:

### Front

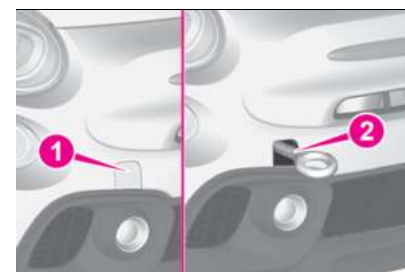

130

AB0A0398C

- ☐ release the cap (1) fig. 130;
- ☐ take the tow hook (2) fig. 130 from its housing in the tool box;
- ☐ fully tighten it on the threaded pin.



## Rear

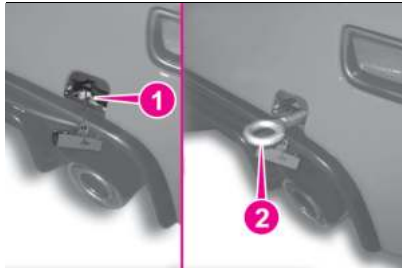

131

AB0A0109C

- ☐ release the cap (1) fig. 131;
- ☐ take the tow hook (2) fig. 131 from its housing in the tool box;
- ☐ fully tighten it on the threaded pin.

### Towing with robotised sequential transmission

Make sure that the transmission is in neutral (N) (checking that the car moves when pushed) and proceed in the same way as for towing a normal car with a manual transmission. If the gearbox cannot be put in neutral, do not tow the car and contact an Abarth Dealership.



#### WARNING

**143)** Before towing, turn the ignition key to MAR-ON and then to STOP without removing it. The steering column will automatically lock when the key is

removed and the wheels cannot be steered.

**144)** Before tightening the ring clean the threaded housing thoroughly. Make sure that the ring is fully screwed into the housing before towing the car.

**145)** The front and rear tow hooks should be used only for emergencies on the road. You are allowed to tow the vehicle for short distances using an appropriate device in accordance with the highway code (a rigid bar), to move the vehicle on the road in readiness for towing or transporting via a breakdown vehicle. Tow rings **MUST NOT** be used to tow vehicles off the road or where there are obstacles and/or for towing operations using cables or other non-rigid devices. In compliance with the above conditions, towing must take place with the two cars (one towing, the other towed) aligned as much as possible along the same centre line.

**146)** When towing, remember that without the help of the brake servo and electric power steering, a greater effort is required on the pedal and steering wheel. Do not use flexible cables when towing and avoid jerky movements. During towing, make sure that the trailer hitch does not damage any components it is touching. When towing the car, you must comply with all specific traffic regulations related to the towing device and adopt an appropriate driving behaviour. Do not start the engine while towing the car.

**147)** Because of its conformation, the car cannot be loaded onto railway carriages and transported.

# SERVICING AND MAINTENANCE

*Proper maintenance allows car performance to be maintained over time, operating costs to be contained, and safety system performance to be safeguarded.*

*This chapter explains how.*

SCHEDULED SERVICING .....	126
SERVICE SCHEDULE .....	127
PERIODIC CHECKS .....	130
DEMANDING USE OF THE CAR .....	130
CHECKING LEVELS .....	131
BATTERY .....	135
RECHARGING THE BATTERY .....	136
REPLACING THE WINDSCREEN/REAR WINDOW WIPER BLADES .....	137
LIFTING THE VEHICLE .....	138
WHEELS AND TYRES .....	139
CAR INACTIVITY .....	140
BODYWORK .....	141
INTERIOR .....	145



## SCHEDULED SERVICING

Correct servicing is crucial for guaranteeing a long life for the car under the best conditions.

For this reason, Abarth has planned a series of checks and maintenance operations at fixed distance intervals or fixed time intervals, as described in the Service Schedule.

Before each service, it is always necessary to carefully follow the instructions in the Scheduled Servicing Plan (e.g. periodically check level of fluids, tyre pressure, etc.).

Scheduled Servicing is offered by all Abarth Dealerships according to a set time schedule. If, during each operation, in addition to the ones scheduled, the need arises for further replacements or repairs, these may be carried out only with the explicit agreement of the Customer.

### IMPORTANT NOTES

Scheduled Servicing interventions are set out by the Manufacturer. Failure to have them carried out may invalidate the warranty.

It is advisable to inform an Abarth Dealership of any small operating irregularities without waiting for the next scheduled service deadline.

For versions fitted with specific equipment, in addition to what is described in the Service Schedule, refer to the relevant additional items in the dedicated supplements.

## SERVICE SCHEDULE

**WARNING** Once you have carried out the last intervention in the table, continue with the scheduled servicing, maintaining the frequency indicated in the plan by marking each operation with a dot or dedicated note.

Warning: simply restarting the maintenance from the start of the plan may cause the allowed interval to be exceeded for some operations!

Thousands of miles	9	18	27	36	45	54	63	72	81	90
Thousands of kilometres	15	30	45	60	75	90	105	120	135	150
Years	1	2	3	4	5	6	7	8	9	10
Check the tyre condition/wear and, if necessary, adjust the pressure. Check the "Fix&Go" kit condition/expiry (where provided)	•	•	•	•	•	•	•	•	•	•
Check operation of lighting system (headlights, direction indicators, hazard warning lights, boot, passenger compartment, glove compartment, instrument panel warning lights, etc.)	•	•	•	•	•	•	•	•	•	•
Check and, if necessary, top up fluid levels (1)	•	•	•	•	•	•	•	•	•	•
Check exhaust emissions/smokiness	•	•	•	•	•	•	•	•	•	•
Use the diagnosis socket to check supply/engine management system operation, emissions and, where present, engine oil degradation	•	•	•	•	•	•	•	•	•	•
Visually inspect condition of: exterior bodywork, underbody protection, pipes and hoses (exhaust, fuel system, brakes), rubber elements (gaiters, sleeves, bushes, etc.)	•		•		•		•		•	
Check windscreen/rear window wiper blade position/wear (where provided)	•		•		•		•		•	
Check operation of the windscreen wiper/washer system and adjust nozzles, if necessary	•		•		•		•		•	



Thousands of miles	9	18	27	36	45	54	63	72	81	90
Thousands of kilometres	15	30	45	60	75	90	105	120	135	150
Years	1	2	3	4	5	6	7	8	9	10
Check cleanliness of hood and boot locks, cleanliness and lubrication of linkage		●		●		●		●		●
Check soft top operation while closing and opening; check of seals and lubrication of canvas sliding side guide (only 595C/695C version)	●	●	●	●	●	●	●	●	●	●
Check handbrake lever travel and adjust, if necessary		●		●		●		●		●
Visually inspect conditions and wear of front and rear disc brake pads and operation of pad wear indicator (where present)	●	●	●	●	●	●	●	●	●	●
Visually inspect condition of the accessory drive belt(s)			●						●	
Check tensioning of accessory drive belt(s) and adjust if necessary			●						●	
Visually inspect conditions of toothed timing drive belt			●						●	
Check the oil level in the robotised sequential transmission activation system (2)		●		●		●		●		●
Check and, if necessary, restore the self-locking differential pre-loading (where present) (3)		●		●		●		●		●
Change the oil of the transmission equipped with self-locking differential (where present) (3) (4)		●		●		●		●		●
Change engine oil and replace oil filter	●	●	●	●	●	●	●	●	●	●
Spark plug replacement(5)		●		●		●		●		●
Replace toothed timing drive belt	(6)									
Replace accessory drive belt/s	(6)									

Thousands of miles	9	18	27	36	45	54	63	72	81	90
Thousands of kilometres	15	30	45	60	75	90	105	120	135	150
Years	1	2	3	4	5	6	7	8	9	10
Replace air cleaner cartridge (7)		●		●		●		●		●
Change the brake fluid	(8)									
Replace passenger compartment cleaner (7) (○) (●)	○	●	○	●	○	●	○	●	○	●

(1) Only ever use the fluids shown in the handbook for topping up, and only after checking that the system is intact.

(2) Only for cars on the road in countries with particularly severe climates (cold countries).

(3) It is recommended to carry out this operation immediately after each time the car has undergone demanding use.

(4) The first transmission oil change must be done on reaching the first 10,000 km, independently of the time passed.

(5) The following are essential to ensure correct operation and prevent serious damage to the engine: only use spark plugs of the same make and type specially certified for 1.4 Turbo petrol Abarth engines (see the information in the "Engine" paragraph); strictly comply with the spark plug replacement interval given in the Service Schedule; for spark plug replacement it is advisable to contact an Abarth Dealership.

(6) The maximum mileage is 120,000 km. The belt must be replaced every 6 years, regardless of distance travelled. If the vehicle is used in heavy conditions (dusty areas, especially severe weather conditions, very low or very high temperatures for extended periods, urban driving, long periods of idling), the maximum mileage is 60,000 km. The belt must be replaced every 4 years regardless of the mileage.

(7) If the vehicle is used in dusty areas, this cleaner should be replaced every 15,000 km.

(8) The brake fluid replacement has to be done every two years, irrespective of the mileage.

(○) Recommended operations.

(●) Mandatory operations.



## PERIODIC CHECKS

Every 1,000 km or before long journeys, check and, if necessary, top up:

- ☐ engine coolant level;
- ☐ brake fluid level;
- ☐ windscreen washer fluid level;
- ☐ tyre inflation pressure and condition;
- ☐ operation of lighting system (headlights, direction indicators, hazard warning lights, etc.);
- ☐ operation of screen washer/wiper system and positioning/wear of windscreen/rear window wiper blades.

Every 3,000 km check and top up if required: engine oil level.

You are advised to use PETRONAS LUBRICANTS products, which have been designed and produced specifically for Abarth cars (see table "Capacities" in the "Technical specifications" chapter).

## DEMANDING USE OF THE CAR

If the car is used mainly under one of the following conditions:

- ☐ if the car is used under demanding conditions, e.g. on track;
- ☐ dusty roads;
- ☐ short, repeated journeys (less than 7-8 Km) at sub-zero outdoor temperatures;
- ☐ engine often idling or driving long distances at low speeds or long periods of inactivity.

The following checks must be carried out more often than indicated in the Service Schedule:

- ☐ check front disc brake pad condition and wear;
- ☐ check cleanliness of bonnet and luggage compartment locks, cleanliness and lubrication of linkage;
- ☐ visually inspect conditions of: engine, gearbox, transmission, pipes and hoses (exhaust/fuel system/brakes) and rubber elements (gaiters/sleeves/bushes, etc.);
- ☐ check battery charge and battery fluid level (electrolyte);
- ☐ visually inspect conditions of the accessory drive belts;
- ☐ check and, if necessary, change engine oil and replace oil filter;

☐ check and, if necessary, replace pollen filter;

☐ check and, if necessary, replace air cleaner.

## CHECKING LEVELS



33)



148) 149) 34)

135 HP, 145 HP and 160 HP versions

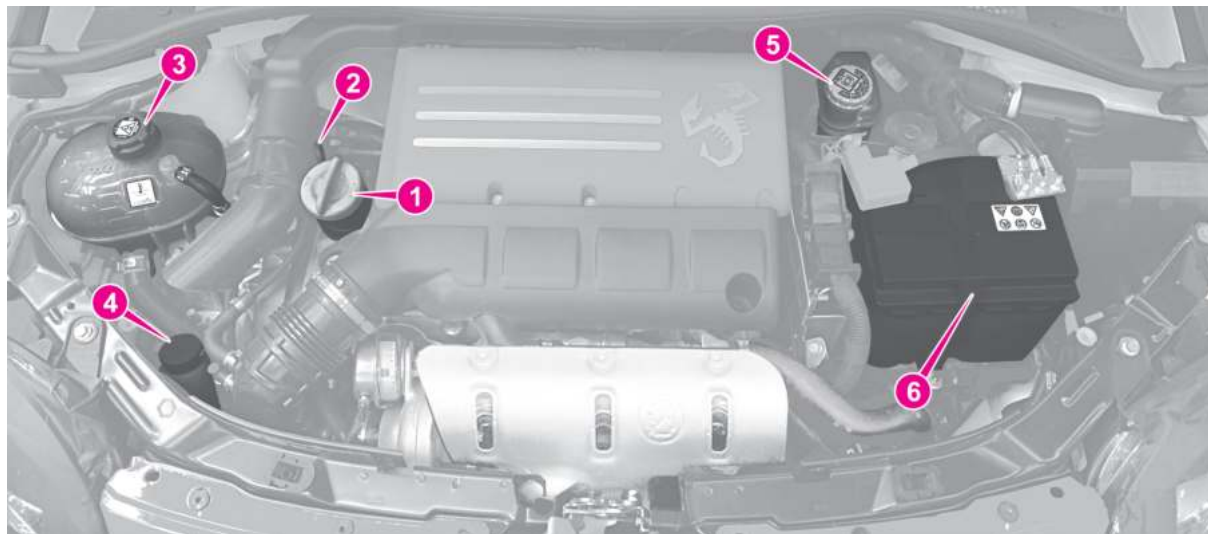

132

AB0A0353C

1. Engine oil filler 2. Engine oil dipstick 3. Engine coolant 4. Windscreen washer fluid 5. Brake fluid 6. Battery



## 163 HP, 165 HP and 180 HP versions

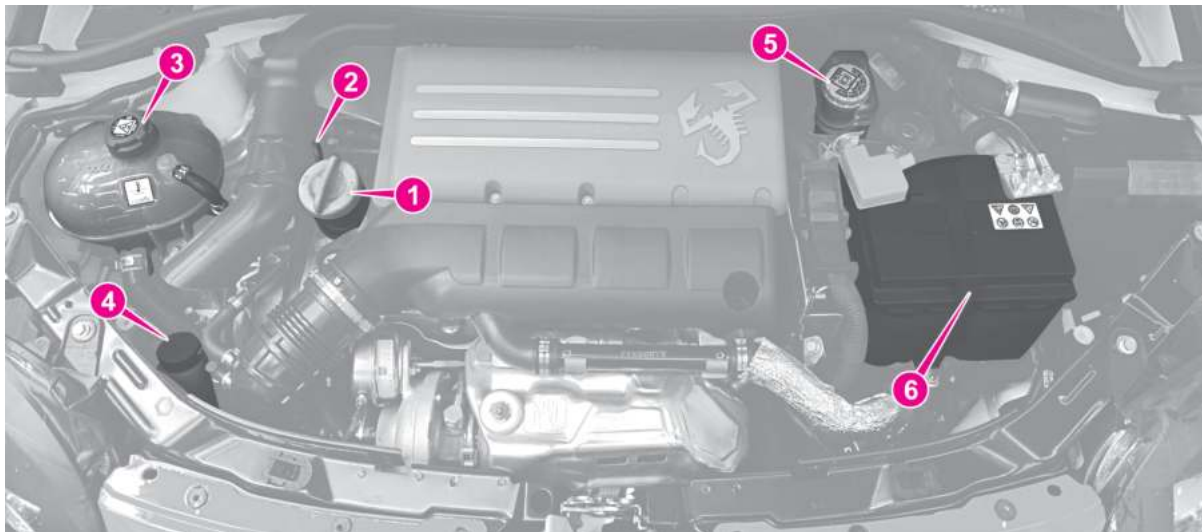

133

AB0A0349C

1. Engine oil filler 2. Engine oil dipstick 3. Engine coolant 4. Windscreen washer fluid 5. Brake fluid 6. Battery

**WARNING**

**148)** *Never smoke while working in the engine compartment: gas and inflammable vapours may be present, with the risk of fire.*

**149)** *Be very careful when working in the engine compartment when the engine is hot: you may get burned. Remember that the fan may start up if the engine is hot: this could injure you. Scarves, ties and other loose clothing might be pulled by moving parts.*



## IMPORTANT

**33)** Be careful not to confuse the various types of fluids while topping up: they are not compatible with one another! Topping up with an unsuitable fluid could severely damage your vehicle.

**34)** Abarth 595/695 is designed and built for road use, in compliance with the current regulations. Car use in the track must be considered as occasional and in any case under the responsibility of the user. The car CANNOT be modified or tampered with for any reason; this would alter the Manufacturer type-approval and/or safety requirements. Using a modified or tampered product relieves the Manufacturer from any responsibility on the product and may expose people to serious risks.



**ENGINE OIL**

Check the oil level a few minutes (about 5) after the engine has stopped, with the vehicle parked on level ground.

Take out the engine oil dipstick (2) fig. 132 or fig. 133, clean it with a lint-free cloth and reinsert it. Extract the engine oil dipstick again and check that the level is between the MIN and MAX marks on the dipstick.

The range between the MIN and MAX marks corresponds to about 1 litre of oil.

If the level of the oil is close to or even below the MIN mark, add oil through the filler fitting (1) fig. 132 or fig. 133 until the MAX mark is reached. The oil level must never exceed the MAX mark.

**Engine oil consumption**

The maximum engine oil consumption is usually 400 grams every 1000 km. When the car is new, the engine needs to be run in; therefore the engine oil consumption can only be considered stabilised after the first 5000 - 6000 km.

**WARNING** The oil consumption depends on driving style and the conditions under which the car is used.

**WARNING** After adding or changing the oil, let the engine turn over for a few seconds and wait a few minutes after turning it off before you check the level.

**ENGINE COOLANT**

The coolant level must be checked when the engine is cold and must range between the MIN and MAX marks on the reservoir.

If the level is too low, unscrew the cap (3) fig. 132 or fig. 133 of the reservoir and add the fluid described in the "Technical Specifications" chapter.

**WINDSCREEN/REAR WINDOW WASHER FLUID**

Check fluid level through the reservoir. If the level is too low, lift reservoir cap (4) fig. 132 or fig. 133 and add the fluid described in the "Technical specifications" chapter.

After topping up, close cap (4), making sure it is correctly locked.

**BRAKE FLUID**

Check that the fluid is at the maximum level (the fluid level in the reservoir must not exceed the MAX mark).

If the fluid level in the reservoir is too low, undo reservoir cap (5) fig. 132 or fig. 133 and add the fluid described in the "Technical Specifications" chapter.



**WARNING** Carefully clean the cap of the reservoir (5) and the surrounding surface. Take great care to ensure that impurities do not enter the reservoir when the cap is opened. Always use a funnel with a built-in filter with a mesh of 0.12 mm or less.

**WARNING** Brake fluid is hygroscopic (i.e. it absorbs moisture). For this reason, if the car is mainly used in areas with a high degree of atmospheric humidity, the fluid must be replaced at more frequent intervals than specified on the "Service Schedule".



## WARNING

**150)** The cooling system is pressurised. If necessary, only replace the plug with another original or the operation of the system may be adversely affected. Do not remove the reservoir plug when the engine is hot: you risk scalding yourself.

**151)** Do not travel with the windscreen washer fluid reservoir empty: the windscreen washer is essential for improving visibility. Some commercial windscreen washer additives are flammable. The engine compartment contains hot components which may set it on fire.

**152)** Brake fluid is poisonous and highly corrosive. In the event of accidental contact, immediately wash the affected parts with water and mild soap. Then rinse thoroughly. Call a doctor immediately if swallowed.

**153)** The  symbol on the reservoir identifies synthetic brake fluids, distinguishing them from the mineral type. Use of mineral type fluids will damage the special rubber seals of the braking system beyond repair.



## IMPORTANT

**35)** Always top up using engine oil of the same specifications as that already in the engine.

**36)** PARAFLUUP anti-freeze is used in the engine cooling system. Use the same fluid as in the cooling system when topping up. PARAFLUUP may not be mixed with other

types of fluids. If this happens, do not start the engine under any circumstances and contact an Abarth Dealership.

**37)** Prevent brake fluid, which is highly corrosive, from coming into contact with painted parts. Should it happen, immediately wash with water.



## IMPORTANT

**4)** Used engine oil and oil filters contain substances which are harmful to the environment. You are advised to go to an Abarth Dealership to have the oil and filters changed.

## BATTERY

The car is fitted with a low-maintenance battery: no electrolyte top-ups with distilled water are needed in standard conditions of use.

## INSPECTING THE CHARGE AND THE ELECTROLYTE LEVEL

The operations must be carried out as described in this Owner Handbook only by specialised technicians. Any top-up operations must be carried out by skilled personnel and by an Abarth Dealership.

## REPLACING THE BATTERY

 154)  155)  156)  157)  38)  5)



If required, replace the battery with a genuine spare part with the same specifications.

If a battery with different specifications is fitted, the service intervals given in the "Service Schedule" will no longer be valid.

Follow the battery manufacturer's instructions for maintenance.

## USEFUL ADVICE FOR EXTENDING THE LIFE OF YOUR BATTERY

To avoid draining your battery and make it last longer, observe the following instructions:

-  when you park the car, ensure that the doors, tailgate and bonnet are closed properly, to prevent any lights from remaining on inside the passenger's compartment;
-  switch off all roof lights inside the car: the car is however equipped with a system which switches all internal lights off automatically;
-  do not keep accessories (e.g. **Uconnect™**, hazard warning lights, etc.) switched on for a long time when the engine is not running;



☐ before performing any operation on the electrical system, disconnect the cable from the negative battery terminal;

☐ completely tighten the battery terminals.

**WARNING** If the charge level remains under 50% for a long time, the battery is damaged by sulphation, reducing its capacity and efficiency at start-up. The battery will also be more at risk of freezing (this can happen as early as -10°C). Refer to the "Car inactivity" paragraph in "Starting and driving" chapter if the car is left parked for a long time. If after buying the car, you want to install electrical accessories that require permanent electrical supply (alarm, etc.) or accessories that in any case burden the electrical supply, contact an Abarth Dealership whose qualified personnel, in addition to suggesting the most suitable devices available in Lineaccessori Abarth, will evaluate the overall electric consumption, checking whether the car's electrical system is capable of withstanding the load required, or whether it should be integrated with a more powerful battery. Since some of these devices continue to consume electricity even when the engine is off, they gradually run down the battery.



### WARNING

**154)** *Battery fluid is poisonous and corrosive. Avoid contact with the skin and eyes. Keep open flames away from the battery and do not use objects that might create sparks: risk of explosion and fire.*

**155)** *Using the battery with low fluid will irreparably damage the battery and may cause an explosion.*

**156)** *If the car must remain unused for a long time at a very low temperature, remove the conventional battery and take it to a warm place, to avoid freezing.*

**157)** *Always wear appropriate goggles to protect your eyes when working on or near the conventional battery.*



### IMPORTANT

**38)** *Incorrect installation of electric and electronic devices may cause severe damage to your car. After purchasing your car, if you wish to install any accessories (car alarm, car phone etc.), please contact your Abarth Dealership, which will suggest the most appropriate devices for your car and will, most importantly, recommend installing a higher-capacity battery.*



### IMPORTANT

**5)** *Batteries contain substances which are very harmful for the environment. It is advisable to contact an Abarth Dealership for battery replacement.*

## RECHARGING THE BATTERY



158) 159)

**WARNING** The battery recharging procedure is given as information only. It is advisable to contact an Abarth Dealership to have this operation performed. Charging should be slow at a low ampere rating for approximately 24 hours. Charging for a longer time may damage the battery.

To recharge, proceed as follows:

- ☐ disconnect the terminal from the negative battery pole;
- ☐ connect the charger cables to the battery terminals, observing the polarity;
- ☐ turn on the battery charger;
- ☐ when it is recharged, turn the charger off before disconnecting it from the battery;
- ☐ reconnect the terminal to the negative battery pole.

**WARNING** The cables of the electrical system must be correctly reconnected to the battery, i.e. the positive cable (+) to the positive terminal and the negative cable (-) to the negative terminal. The battery terminals are marked with the positive (+) and

negative (-) symbols, and are shown on the battery cover. The battery terminals must also be corrosion-free and firmly secured to the terminals. If a "quick-type" battery charger is used with the battery fitted on the car, before connecting it disconnect both cables of the battery itself. Do not use a "quick-type" battery charger to provide the starting voltage.



## WARNING

**158)** Battery fluid is poisonous and corrosive: avoid contact with your skin and eyes. The battery should be charged in a well ventilated place, away from naked flames or possible sources of sparks: danger of explosion and fire.

**159)** Do not attempt to recharge a frozen battery: first it must be thawed, otherwise there is a risk of explosion. If freezing has occurred, the battery should be checked by skilled personnel to make sure that the internal elements are not damaged and that the body is not cracked, with the risk of leaking poisonous and corrosive acid.

## REPLACING THE WINDSCREEN/REAR WINDOW WIPER BLADES

### WIPER BLADES

Replace the blades if the rubber edge is deformed or worn. In any case, it is advisable to replace them approximately once a year.



A few simple precautions can reduce the possibility of damage to the blades:

- ▣ if the temperature falls below zero, make sure that ice has not frozen the rubber to the glass. Use a de-icing product to release it if required;
- ▣ remove any snow from the glass: in addition to protecting the blades, this prevents effort on the motor and overheating;
- ▣ do not operate the windscreen and rear window wipers on dry glass.

### RAISING THE WINDSCREEN WIPER BLADES

Lift the windscreen wiper arm and position the blade so that it forms a 90° angle with the arm.

## REPLACING WIPER BLADES

Proceed as follows:

- ▣ lift up the windscreen wiper arm (1) fig. 134 and position the blade so that it forms a 90° angle with the arm;
- ▣ press the button (1) and extract from the arm (2) the blade (3);
- ▣ insert the new blade making sure it is locked into place.

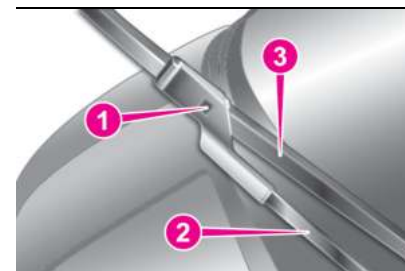

134

AB0A0112C

## REPLACING THE REAR WINDOW WIPER BLADE

Proceed as follows:

- ▣ raise the cover (1) fig. 135 and remove the arm from the car, undoing the nut (2) fig. 135 that fixes it to the pivot pin;
- ▣ correctly position the new arm and tighten the nut fully;
- ▣ lower the cover.



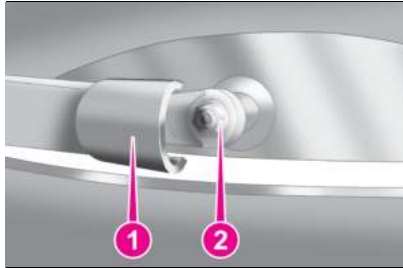

135

AB0A0113C

## NOZZLES

### Windscreen washer

If there is no jet, first check that there is fluid in the reservoir (see the "Checking fluid levels" paragraph in this chapter). Then check that the nozzle holes are not clogged; use a needle to unblock them if necessary.

The screen washer jets can be oriented by adjusting the nozzle angles.

The jets should be directed at about 1/3 of the height from the top edge of the windscreen fig. 136.

**WARNING** In versions with a sunroof, make sure that the sunroof is closed before operating the front jets.

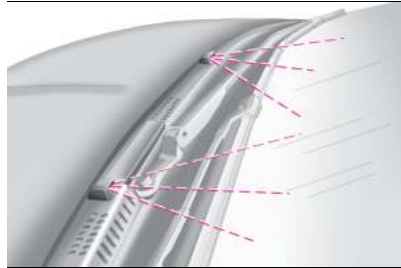

136

AB0A0114C

### Rear window washer

The rear window washer jets are fixed. The nozzle holder is located above the rear window fig. 137.

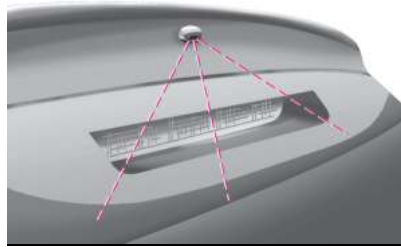

137

AB0A0115C



## WARNING

**160)** Driving with worn windscreen/rear window wiper blades is a serious risk, because visibility is reduced in bad weather.

## LIFTING THE VEHICLE



As a result of its sporty nature, the car is fitted with aerodynamic spoilers at the bottom and side skirts at the sides. If the car needs to be raised, go to an Arath Dealership which is equipped with arm lifts and workshop lifts.



## IMPORTANT

**39)** When positioning the workshop lift arms, be very careful to avoid damaging the aerodynamic spoilers and the side skirts.

## WHEELS AND TYRES

Check the pressure of each tyre, including the space-saver spare wheel, approximately every two weeks and before long journeys: the pressure should be checked with the tyre rested and cold.

 161) 162) 163) 164)

It is normal for the pressure to increase when the car is used; for the correct tyre inflation pressure, see the "Wheels" paragraph in the "Technical specifications" chapter.

Incorrect pressure causes abnormal tyre wear fig. 138:

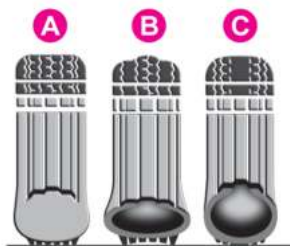

138

AB0A0343C

**A** normal pressure: tread evenly worn.

**B** low pressure: tread particularly worn at the edges.

**C** high pressure: tread particularly worn in the centre.

The tyres must be replaced when the tread is less than 1.6 mm thick. In any

case, follow the laws in force in the country where you are driving.

### WARNINGS

▮ As far as possible, avoid sharp braking, screech starts and violent shocks against pavements, potholes or other hard obstacles. Driving for long stretches over uneven roads can damage the tyres;

▮ periodically check that the tyres have no cuts in the side wall, abnormal swelling or irregular tyre tread wear. Contact an Abarth Dealership if required.

▮ avoid overloading the car when travelling: this may cause serious damage to the wheels and tyres;

▮ if a tyre is punctured, stop immediately and replace it to avoid damage to the tyre, the rim, suspension and steering system;

▮ tyres age even if they are not used much. Cracks in the tread and on the sidewalls are a sign of ageing. In any event, have the tyres checked by specialised technicians if they have been fitted for longer than 6 years. Also remember to check the space-saver spare wheel with particular care;

▮ in the case of replacement, always fit new tyres, avoiding those of unknown origin;

▮ if a tyre is changed, also change the inflation valve;

▮ to allow even wear between the front and rear tyres, it is advisable to change them over every 10–15 thousand kilometres, keeping them on the same side of the car to avoid inverting the direction of rotation.

### SNOW TYRES

Use snow tyres of the same size as the standard tyres provided with the car.

An Abarth Dealership will be happy to provide advice concerning the most suitable type of tyre for the Customer's requirements.

 165)

For the type of tyre to be used, inflation pressures and the specifications of snow tyres, follow the instructions given in the "Wheels" paragraph in the "Technical specifications" chapter.

The winter features of these tyres are reduced considerably when the tread depth is below 4 mm. Replace them in this case.

Due to the specific characteristics of snow tyres, in normal weather conditions or on long motorway journeys, the performance of these tyres is lower than that of standard tyres. Their usage should therefore be restricted in accordance with their type approval.



**WARNING** When using snow tyres with a maximum speed index below the one that can be reached by the car (increased by 5%), place a notice in the passenger compartment, plainly in view, which states the maximum speed allowed by the snow tyres (as per EC Directive).

All four tyres should be the same (brand and track) to ensure greater safety when driving and braking as well as a good manoeuvrability.

Remember that you should not change the rotation direction of the tyres.

### SNOW CHAINS

The use of snow chains should be in compliance with local regulations of each country.

Snow chains can be fitted to the tyres of the front wheels (drive wheels) only. Check the tension of the snow chains after the first few feet/meters have been driven.



### WARNING

**161)** Remember that the road holding qualities of your car also depend on correct tyre pressures.

**162)** If tyre pressure is too low, it may overheat and be severely damaged as a result.

**163)** Do not switch tyres from the right-hand side of the car to the left-hand side, and vice versa.

**164)** Do not repaint alloy wheel rims at temperatures higher than 150°C. The mechanical features of the wheels could be compromised.

**165)** The max. speed for snow tyres with "Q" marking is 160 km/h. The Road Traffic Code speed limits must however be always strictly observed.



### IMPORTANT

**40)** Keep your speed down when snow chains are fitted; do not exceed 50 km/h. Avoid potholes, do not drive over steps or pavements and do not drive long distances over roads without snow, to avoid damaging both your car and the road surface.

## CAR INACTIVITY

If the car is to be left inactive for longer than a month, the following precautions should be noted:

- ☐ park the car in covered, dry and if possible well-ventilated premises and slightly open the windows;
- ☐ check that the handbrake is not engaged;
- ☐ engage a gear;
- ☐ disconnect the negative battery terminal and check the battery charge. Repeat this check once every three months during storage;
- ☐ if the battery is not disconnected from the electrical system, check its state of charge every thirty days;
- ☐ clean and protect the painted parts using protective wax;
- ☐ clean and protect the shiny metal parts using special compounds available commercially;
- ☐ sprinkle talcum powder on the windscreen and rear window wiper rubber blades and lift them off the glass;
- ☐ cover the car with a cloth or perforated plastic sheet. Do not use compact plastic sheets which do not allow humidity to evaporate from the surface of the car;
- ☐ inflate tyres to +0.5 bar above the standard specified pressure and check it at intervals;

- do not drain the engine cooling system;
- any time the vehicle is left inactive for two weeks or more, operate the climate control system with engine idling for at least 5 minutes, setting external air and with fan set to maximum speed. This operation will ensure appropriate lubrication for the system, thus minimising the possibility of damage to the compressor when the system is operated again.

**WARNING** After setting the ignition device to STOP and having closed the driver side door, wait at least one minute before disconnecting the electrical supply from the battery.

When reconnecting the electrical supply to the battery, make sure that the ignition device is in the STOP position and the driver side door is closed.

## BODYWORK

### PROTECTION AGAINST ATMOSPHERIC AGENTS

The main causes of corrosion are the following:

- atmospheric pollution;
- salty air and humidity (coastal areas, or hot humid climates);
- seasonal environmental conditions.

The abrasive action of wind-borne atmospheric dust and sand, as well as mud and gravel raised by other cars is also not to be underestimated.

Abarth has used the best manufacturing technologies on your car to effectively protect the bodywork against corrosion.

These include:

- painting products and systems which give the car particular resistance to corrosion and abrasion;
- use of galvanised (or pretreated) sheet metal, with high resistance to corrosion;
- spraying the underbody, engine compartment, wheelhouse internal parts and other parts with highly protective wax products;
- spraying of plastic parts, with a protective function in the more exposed points: underdoor, inner wing, edges, etc.;

- use of “open” boxed sections to prevent condensation and pockets of moisture which could favour the formation of rust inside.

### PRESERVING THE BODYWORK Paintwork

Paintwork does not only serve an aesthetic purpose, but also protects the underlying sheet metal.

You are advised to touch up abrasions and scratches immediately to prevent rust formation. Use only original paint products for touch-ups (see “Bodywork paint identification plate” in the “Technical Specifications” section). Normal care for paintwork consists of washing the car; how often depends on the conditions and environment where the car is used. For example, in highly polluted areas, or if the roads are spread with salt, it is advisable to wash the car more frequently.

To correctly wash the car, proceed as follows:

- remove the aerial from the roof to prevent damage to it if the car is washed in an automatic system;
- if high pressure jets or cleaners are used to wash the car, keep a distance of at least 40 cm from the bodywork to avoid damage or alteration. It should be remembered that the build up of water



can damage the car over a period of time;



- ▣ wash the bodywork using a low pressure jet of water;
- ▣ wipe a sponge with a slightly soapy solution over the bodywork, frequently rinsing the sponge;
- ▣ rinse well with water and dry with a jet of air or a chamois leather.

Dry the less visible parts with special care, such as the door frames, bonnet and the headlight frames, where water may stagnate more easily. The car should not be taken to a closed area immediately, but left outside so that residual water can evaporate.

Do not wash the car after it has been left in the sun or with the bonnet hot: this may alter the shine of the paintwork.

Exterior plastic parts must be cleaned in the same way as the rest of the car.

Where possible, do not park the car under trees; the resinous substances that many species release give the paint a dull appearance and increase the possibility of triggering rusting processes.

**WARNING** Bird droppings must be washed off immediately and thoroughly as the acid they contain is particularly aggressive.   41

### Versions with matt paintwork

These versions have exclusive matt paintwork which requires special care for its preservation. The instructions for good preservation follow below.

- ▣ avoid washing with rollers and/or brushes in washing stations. Then, wash the car, only by hand, using pH-neutral detergents; dry it with a wet chamois leather. Abrasive products and/or polishes should not be used for cleaning the car.
- ▣ Bird droppings must be washed off immediately and thoroughly as the acid they contain is particularly aggressive.
- ▣ Avoid (if at all possible) parking the car under trees; remove vegetable resins immediately as, when dried, it may only be possible to remove them with abrasive products and/or polishes, which is highly inadvisable as they could alter the typical opaqueness of the paint.
- ▣ Do not use pure windscreen washer fluid for cleaning the windscreen and the rear window: dilute it to at least 50% with water.
- ▣ Only use pure screen washer fluid when strictly necessary due to outside temperature conditions. Do not use chemicals/acids to defrost windows/vehicle glass as they can damage the paint.

▣ Some versions are fitted with exclusive decorations on the door mirror covers; do not use pressurised or high-temperature jets of water when washing them.

### Versions with stickers or wrapping

To correctly clean and wash the car, proceed as follows:

- ▣ avoid washing with rollers and/or brushes in washing stations. Then, wash the car, only by hand, using pH-neutral detergents; dry it with a wet chamois leather. Abrasive products and/or polishes should not be used for cleaning the car.
- ▣ The use of solvents, waxes, detergents or similar products is not recommended for the care of the car as they could damage the stickers or cause them to detach. The use of such washing or cleaning instruments and methods will therefore invalidate the warranty.

**NOTE** We recommend using mild products for cleaning the car.

- ▣ It should be remembered that a build up of water could cause damage, in the long term, to the car.
- ▣ Wet the bodywork with a low-pressure water jet.

☞ Wipe a sponge with a slightly soapy solution over the bodywork, frequently rinsing the sponge.

☞ Rinse well with water and dry with a jet of air or a chamois leather. Dry the less visible parts with special care, such as the door frames, bonnet and the headlight frames, where water may stagnate more easily. The car should not be taken to a closed area immediately, but left outside so that residual water can evaporate. Do not wash the car after it has been parked in the sun.

Exterior plastic parts must be cleaned in the same way as the rest of the car. Where possible, do not park the car under trees; the resinous substances that many species release give the paint a dull appearance and increase the possibility of triggering rusting processes.

**WARNING** In case of water stains (rings) on the wrapping, remove it, washing again and drying it with a non-abrasive soft cloth.

#### WARNINGS

☞ Bird droppings must be washed off immediately and thoroughly as the acid they contain is particularly aggressive.

☞ Avoid (if at all possible) parking the car under trees; remove vegetable resins immediately as, when dried, it may only be possible to remove them with abrasive products and/or polishes, which is highly inadvisable as they could alter the paint, the stickers or the wrapping.

☞ Do not use pure windscreen washer fluid for cleaning the windscreen and the rear window: dilute it to at least 50% with water.



#### Windows

To clean glasses, use specific cleaning products.

Use clean cloths to avoid scratching the glass or altering the transparency.

**WARNING** Wipe the rear window inside gently with a cloth following the direction of the filaments to avoid damaging the heating device.



#### Headlights

Use a soft cloth soaked in water and detergent for washing cars.

**WARNING** Never use aromatic substances (e.g. petrol) or ketones (e.g.

acetone) for cleaning the plastic lenses of the headlights.

**WARNING** When cleaning the car with a pressure washer, keep the water jet at least 20 cm away from the headlights.

#### ENGINE COMPARTMENT WASHING



If the engine compartment is washed (at low pressure, e.g. in very dusty areas), this must be done with the engine cold and with ignition device turned to STOP. Take care not to direct the water jet straight at the electronic control modules, fuse box connectors or wiper motors. Moreover, do not direct the jet towards the drop catcher area around the engine oil cap to avoid splashing oil in the engine compartment. Have this operation performed by a specialised workshop. After washing, check that the various protective components (e.g. rubber guards and caps) have not been removed or damaged.

#### WASHING/CLEANING THE SOFT TOP

Use of specific products is recommended for washing the soft top cloth.



The soft top fabric is treated with a special water-repellent, waterproof product. The water-repellent properties will degrade in time with exposure to the weather elements.

 46) 47) 48) 49) 50)

Remove as much dirt from the surface of the soft top with a soft brush or vacuum cleaning before washing it. This operation will considerably improve the final result.

In lack of specific products, use water and neutral soap applied with a sponge (preferably in the shade) for washing. Rinse the soft top with clean water after having eliminated all the stains. Hand washing is recommended; modern automatic washing systems equipped with soft brushes which do not apply excessive pressure and employ specific soft top products may be used.

 51)

Leave the car in the shade after washing avoiding direct sunlight.

### Waterproofing the soft top

Use specific waterproofing products for fabric soft tops.

 52) 53)

### Interior soft top fabric

Remove dust with a soft brush. Avoid using hard brushes made of synthetic material to prevent damaging the fabric beyond repair.

Clean the surface with a microfibre cloth or soft sponge dipped in a solution of water and neutral soap. Clean the entire surface, including the zones where cleaning is not needed, to prevent staining.

Use common, care mild stain removers that can be purchased from car cleaning product ranges to remove more stubborn stains. Apply by blotting (never rubbing) directly on the area of the stain.



### IMPORTANT

**41)** *Abrasive products and/or polishes should not be used for cleaning the car. Bird droppings must be washed off immediately and thoroughly as the acid they contain is particularly aggressive. Avoid parking the vehicle under trees (unless it is absolutely necessary). Remove any resinous plant matter immediately because, once it has dried, it may require the use of abrasive and/or polishing products to be removed, which are strongly discouraged as they could potentially alter the characteristics of the paintwork. Do not use pure windscreen washer fluid for cleaning the front windscreen and rear window; dilute it min. 50% with water. Only use pure screen washer fluid when strictly necessary due to outside temperature conditions. Do not use chemicals/acids to*

*defrost windows/vehicle glass as they can damage the paint.*

**42)** *It is not advisable to wash with pressure washer or, in case of use, it is necessary to maintain at least a minimum distance of 40 cm with water at room temperature.*

**43)** *Abrasive products and/or polishes should not be used for cleaning the car*

**44)** *Do not use pure windscreen washer fluid for cleaning the windscreen and the rear window: dilute it to at least 50% with water.*

**45)** *A high pressure jet cleaner should not be used for cleaning the engine compartment. The appropriate precautions have been taken to protect all parts and connections, but the pressures generated by these devices are so high that complete protection against water seepages cannot be guaranteed.*

**46)** *Bird droppings and plant resins must be washed off immediately and thoroughly as the acid they contain is particularly aggressive.*

**47)** *Never use high-pressure washing systems.*

**48)** *When using steam washers or high-pressure water washers, maintain a suitable distance and do not exceed a maximum temperature of 60°C. Damage, alterations and water infiltration may occur if the distance is too small and the pressure is too high.*

**49)** *If a water jet is used, direct away from the edges of the fabric and the rear window frame to prevent water infiltration.*

**50)** *Never use alcohol, petrol, chemical products, detergents, stain removers, wax, solvents and "wash and polish" products.*

**51)** Rinse immediately to remove soap to prevent stains. Repeat the operation if needed.

**52)** Follow the instructions on the waterproofing product container for perfect results.

**53)** The rubber seals on the soft top must be cleaned exclusively with water. If you notice that this trim is dry or is sticking, apply talcum powder or products specifically for rubber trim (silicone spray).



### IMPORTANT

**6)** Detergents pollute the water. Only wash your vehicle in areas equipped to collect and treat waste water from this type of activity.

## INTERIOR

Regularly check that water is not trapped under the mats (due to water dripping off shoes, umbrellas, etc.), as this could cause oxidation of the sheet metal.

166) 167)

### FABRIC SEATS AND PARTS

Remove dust with a soft brush or a vacuum cleaner. It is advisable to use a moist brush on velvet upholstery. Rub the seats with a sponge moistened with a solution of water and neutral detergent.

### PLASTIC AND COATED PARTS

It is advisable to clean interior plastic parts with a moist cloth and a solution of water and non-abrasive mild soap. Use specific products for cleaning plastic, without solvents and specifically designed to prevent damage to the appearance and colour of the treated parts, to remove grease and tough stains.

**WARNING** Never use alcohol, petrols and derivatives to clean the instrument panel lens.

### LEATHER PARTS

(where provided)

Use only water and neutral soap to clean these parts. Never use alcohol or alcohol-based products.

Before using a specific product for cleaning interiors, make sure that it does not contain alcohol and/or alcohol-based substances.

### ALCANTARA PARTS (STEERING WHEEL)

Procedure for restoring Alcantara applied to the steering wheel:

☐ Treat the surface using a microfibre cloth moistened with neutral soap and water, taking care to cover the whole

covered area, applying a uniform light pressure (do not rub hard).

☐ Rinse and wring out the microfibre cloth, and pass over the covered area treated in the previous point again.

☐ Leave it to dry and brush it gently with a soft brush.

54)



### WARNING

**166)** ever use flammable products, such as petrol ether or rectified petrol to clean the inside of the car. The electrostatic charges which are generated by rubbing during the cleaning operation may cause a fire.

**167)** Do not keep aerosol cans in the car: they might explode. Aerosol cans must not be exposed to a temperature exceeding 50°C. When the vehicle is exposed to sunlight, the internal temperature can greatly exceed this value.



### IMPORTANT

**54)** Do not use "hard" synthetic brushes as they could damage the fabric beyond repair. Clean the steering-wheel completely to prevent differences in appearance between treated and untreated zones. Do not use alcohol or ketone-based solvents.



# TECHNICAL SPECIFICATIONS

*Everything you may find useful for understanding how your car is made and works is contained in this chapter and illustrated with data, tables and graphics. For the enthusiasts and the technician, but also just for those who want to know every detail of their car.*

IDENTIFICATION DATA .....	147
ENGINE .....	148
INTAKE SYSTEM .....	150
TRANSMISSION .....	151
BRAKES .....	152
SUSPENSION .....	153
STEERING .....	154
WHEELS .....	155
DIMENSIONS .....	159
WEIGHTS AND LOADS .....	160
REFUELLING .....	161
FLUIDS AND LUBRICANTS .....	162
PERFORMANCE .....	164
FUEL CONSUMPTION AND CO <sub>2</sub> EMISSIONS .....	165
PRESCRIPTIONS FOR HANDLING THE CAR AT THE END OF ITS LIFE .....	166

## IDENTIFICATION DATA

The following identification codes are printed and shown on the plates:

- Vehicle identification number (VIN) plate.
- Chassis marking.
- Bodywork paint identification plate.
- Motor marking.

### VEHICLE IDENTIFICATION NUMBER (VIN) PLATE

It is applied to the left side of the rear floor in the luggage compartment or, depending on the version, on the passenger-side rear pillar. It contains the following information fig. 139:

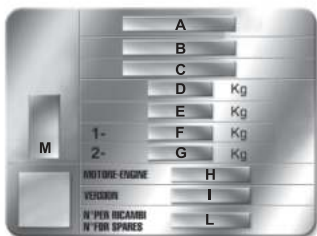

I 39

F1D1044

- A** Name of Manufacturer.
- B** Type-approval number.
- C** Car type identification code and progressive vehicle identification number (VIN).

- D** Maximum authorized weight of vehicle fully laden.
- E** Maximum authorised weight of fully laden car plus trailer.
- F** Maximum permitted weight on first axle (front).
- G** Maximum permitted weight on second axle (rear).
- H** Engine type.
- I** Bodywork version code.
- L** Spare part reference number.
- M** Colour code (for versions/markets, where provided).

### CHASSIS MARKING

It is located on the right side of the luggage compartment floor and bears the following data fig. 140:

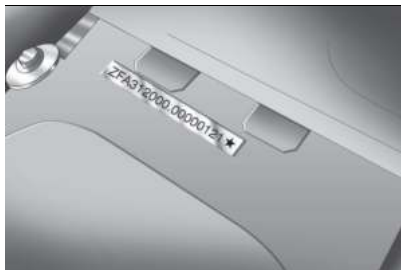

I 40

AB0A0345C

- car type;
- chassis serial number.

## BODYWORK PAINT IDENTIFICATION PLATE

The plate is applied on the external tailgate post (left side) and it bears the following data fig. 141:

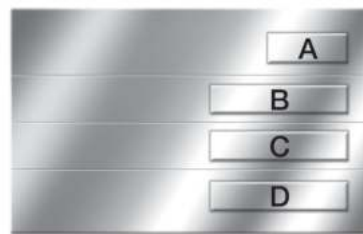

I 41

AB0A0344C

- A** Paint manufacturer.
- B** Colour name.
- C** Colour code.
- D** Respray and touch up code.

### MOTOR MARKING

It is stamped on the cylinder block and includes the type and the engine serial number.



**ENGINE**

(For markets where provided)

GENERAL INFORMATION	1.4 TB PETROL ABARTH 135 HP	1.4 TB PETROL ABARTH 145 HP	1.4 TB PETROL ABARTH 160 HP
Engine code	312A1000	312B4000	312B4000
Cycle	Otto	Otto	Otto
Number and position of cylinders	4 in line	4 in line	4 in line
Piston bore and stroke (mm)	72 x 84	72 x 84	72 x 84
Total displacement (cm <sup>3</sup> )	1368	1368	1368
Compression ratio	9.8 : 1	9.8 : 1	9.8 : 1
Maximum power (CEE) (kW)	99	107	118
Maximum power (CEE) (HP)	135	145	160
Corresponding engine speed (rpm)	5500	5500	5500
Maximum torque (CEE) (Nm)	180 (**) / 206 (***)	180 (**) / 210 (***)	210 (**) / 230 (***)
Corresponding engine speed (rpm)	2000	2000 (**) / 2500 (***)	2000 (**) / 3000 (***)
Spark plugs	NGK IKR9F8	NGK IKR9F8	NGK IKR9F8
Fuel	Unleaded petrol 95 RON (Specification EN228)	Unleaded petrol 95 RON or 98 RON (Specification EN228)	Unleaded petrol 95 RON or 98 RON (Specification EN228)

(\*\*) NORMAL

(\*\*\*) SPORT

GENERAL INFORMATION	1.4 TB PETROL ABARTH 163 HP	1.4 TB PETROL ABARTH 165 HP	1.4 TB PETROL ABARTH 180 HP(*)	1.4 TB PETROL ABARTH 180 HP
Engine code	312B6000	312B3000	312B3000	312A3000
Cycle	Otto	Otto	Otto	Otto
Number and position of cylinders	4 in line	4 in line	4 in line	4 in line
Piston bore and stroke (mm)	72 x 84	72 x 84	72 x 84	72 x 84
Total displacement (cm <sup>3</sup> )	1368	1368	1368	1368
Compression ratio	9.0 : 1	9.0 : 1	9.0 : 1	9.0 : 1
Maximum power (CEE) (kW)	120 (****)	121 (****)	132 (****)	132 (****)
Maximum power (CEE) (HP)	163 (****)	165 (****)	180 (****)	180 (****)
corresponding revolutions per minute (rpm)	5500	5500	5500	5500
Maximum torque (CEE) (Nm)	210 (**) / 230 (***)	210 (**) / 230 (***)	230 (**) / 250 (***)	230 (**) / 250 (***)
corresponding revolutions per minute (rpm)	2000 (**) / 2250 (***)	2000 (**) / 2250 (***)	2000 (**) / 2500 (***)	2000 (**) / 2500 (***)
Spark plugs	NGK IKR9F8	NGK IKR9F8	NGK IKR9F8	NGK IKR9F8
Fuel	Unleaded petrol 95 RON or 98 RON (Specification EN 228)	Unleaded petrol 95 RON or 98 RON (Specification EN 228)	Unleaded petrol 95 RON or 98 RON (Specification EN 228)	Unleaded petrol 95 RON or 98 RON (Specification EN 228)

(\*) Kit (for versions/markets, where provided)

(\*\*) NORMAL

(\*\*\*) SPORT

(\*\*\*\*) Results obtained using 98 RON unleaded petrol



## INTAKE SYSTEM

Model	1.4 TB PETROL ABARTH
Intake system	Timed sequential electronic injection, with fixed geometry turbocharger



### WARNING

**168)** *Modifications or repairs to the fuel supply system that are not carried out properly or do not take the system's technical specifications into account can cause malfunctions leading to the risk of fire.*

## TRANSMISSION

Model	1.4 TB PETROL ABARTH
Transmission	Five forward gears and reverse with synchronisers for forward gear engagement
Transmission with self-locking differential (where present)	Five forward gears plus reverse with synchronisers for forward and reverse gears, and self-locking differential with ramps and discs
Clutch	Self-adjusting pedal without idle stroke
Traction	Front

Model	1.4 TB PETROL ABARTH - ROBOTISED SEQUENTIAL GEARBOX
Transmission	Five forward speeds plus reverse with electronically managed electro-hydraulic control system
Clutch	Electronically controlled electro-hydraulic system
Traction	Front

The mechanical self-locking differential of the car (where present) is of the clutch plate and ramp type, the most used in the racing world.

When the grip on the road surface is not good, the limited slip differential ensure that the drive torque is distributed between all the wheels to maximise the traction.

In this way, it improve the car's ability to transfer the torque to the ground and maintain its trajectory on bends, benefitting safety and sportiness.



## BRAKES

Model	1.4 TB PETROL ABARTH 135 HP – 145 HP	
Service brakes	front	rear
	self-ventilated discs	solid disc

Model	1.4 TB PETROL ABARTH 165 HP	
Service brakes	front	rear
	perforated self-ventilated discs	perforated solid discs

Model	1.4 TB PETROL ABARTH 180 HP	
Service brakes	front	rear
	perforated self-ventilated discs	perforated solid discs

Model	1.4 TB PETROL ABARTH	
Parking brake	controlled by hand lever, working on rear brakes	

WARNING Water, ice and salt spread on the roads may deposit on the brake discs, reducing braking efficiency the first time the brakes are applied.

## SUSPENSION

Model	1.4 TB PETROL ABARTH
Front	MacPherson independent wheels, mechanical crossmember, shock absorbers and coil springs; anti-roll bar.
Rear	torsion beam with interconnected wheels consisting of a torsion axle, anti-roll bar and two tubular arms with shock absorbers and coil springs.



**STEERING**

Model	1.4 TB PETROL ABARTH
Type	rack and pinion with dual strategy electric power steering (normal/sport)
Kerb-to-kerb turning circle (m)	10.8

## WHEELS

### RIMS AND WHEELS

Alloy rims. Tubeless radial carcass tyres. All approved tyres are listed in the registration document.

**WARNING** If there are any discrepancies between the Owner Handbook and the registration document, take the information from the latter. For safe driving, the car must be fitted with tyres of the same make and type on all wheels.

**WARNING** Do not use air chambers with tubeless tyres.

### WHEEL GEOMETRY

Front wheels toe-in measured between rims:  $0.5 \pm 1$  mm. The values refer to the car in running order.

### CORRECT READING OF THE TYRE

**Example fig. 142: 195/45 R 16 84V**

**195** Nominal width (S, distance in mm between sides)

**45** Height/width ratio (H/S), expressed as a percentage

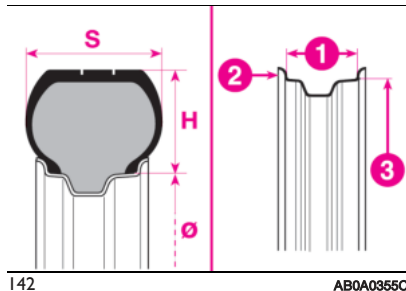

R Radial tyre

**16** Rim diameter in inches (Ø)

**84** Load rating (capacity)

**V** Maximum speed rating

### Maximum speed index

**Q** up to 160 km/h

**R** up to 170 km/h

**S** up to 180 km/h

**T** up to 190 km/h

**U** up to 200 km/h

**H** up to 210 km/h

**V** up to 240 km/h

**W** up to 270 km/h

### Maximum speed index for snow tyres

**QM + S** up to 160 km/h

**TM + S** up to 190 km/h

**HM + S** up to 210 km/h

### Load index (capacity)

**70** = 335 kg      **81** = 462 kg

**71** = 345 kg      **82** = 475 kg

**72** = 355 kg      **83** = 487 kg

**73** = 365 kg      **84** = 500 kg

**74** = 375 kg      **85** = 515 kg

**75** = 387 kg      **86** = 530 kg

**76** = 400 kg      **87** = 545 kg

**77** = 412 kg      **88** = 560 kg

**78** = 425 kg      **89** = 580 kg

**79** = 437 kg      **90** = 600 kg

**80** = 450 kg      **91** = 615 kg

### CORRECT READING OF THE RIM CODE

**Example fig. 142: 7.00 J x 17 H2**

**7.00** width of the rim in inches (1).

**J** rim drop centre outline (side projection where the tyre bead rests) (2).

**17** rim nominal diameter in inches (corresponds to diameter of the tyre to be fitted) (3 = Ø).

**H2** shape and number of "humps" (circumference measurement which



keeps the bead of tubeless tyres in position on the rim).

**RIM PROTECTOR TYRES**



143

AB0A0356C

 169)



**WARNING**

**169)** Do NOT fit wheel hubs when using integral hubs fixed (with springs) to the steel rim, and tyres other than the factory-fitted tyres provided with the Rim Protector (fig. 143). Use of unsuitable tyres and wheel caps may cause sudden decrease of tyre pressure.

## RIMS AND TYRES PROVIDED

Model	Rims	Tyres provided	Snow tyres
1.4 TB PETROL ABARTH	6 1/2 J x 16H2-ET35	195/45 R16 84 V XL (*)	(**)
	7 J x 16H2-ET35	195/45 R16 84 V XL (*)	
	7 J x 17H2-ET35	205/40 R17 84 W XL (***)	
	7 J x 17H2-ET38	205/40 R17 84 W XL (***)	

(\*) 7 mm chains can be fitted.

(\*\*) Winter tyres (Pirelli Snow Sport 195/45 R16) are also available for use if the car is mainly driven on snow-covered roads.

(\*\*\*) Snow chains suitable for 205/40 R17 tyres are available at the Abarth Dealership. These may be used at a maximum speed of 50 km/h. Contact the Abarth Dealership for more information about the use of snow chains.



### COLD TYRE INFLATION PRESSURE (bar)

When the tires are warm, the inflation pressure should be + 0.3 bar in relation to the recommended figure. However, recheck that the value is correct with the tyre cold.

Tyres	Medium load (*)		Full load	
	Front	Rear	Front	Rear
195/45 R16 84 V XL	2.3	2.1	2.6	2.4
205/40 R17 84 W XL	2.3	2.1	2.6	2.4

(\*) At speeds above 160 km/h, use the inflation pressures for the maximum load conditions.

(\*\*) The indicated pressure is aimed at comfort. To privilege fuel efficiency, the inflation pressure can be increased to a maximum of 2.9 bar on the front tyres and up to 2.7 bar on the rear tyres.

## DIMENSIONS

Dimensions are expressed in mm and refer to the vehicle equipped with its standard-supplied tyres. Height is measured with car unladen.

**BOOT VOLUME** Unladen capacity (V.D.A. standards) = 185 dm<sup>3</sup>

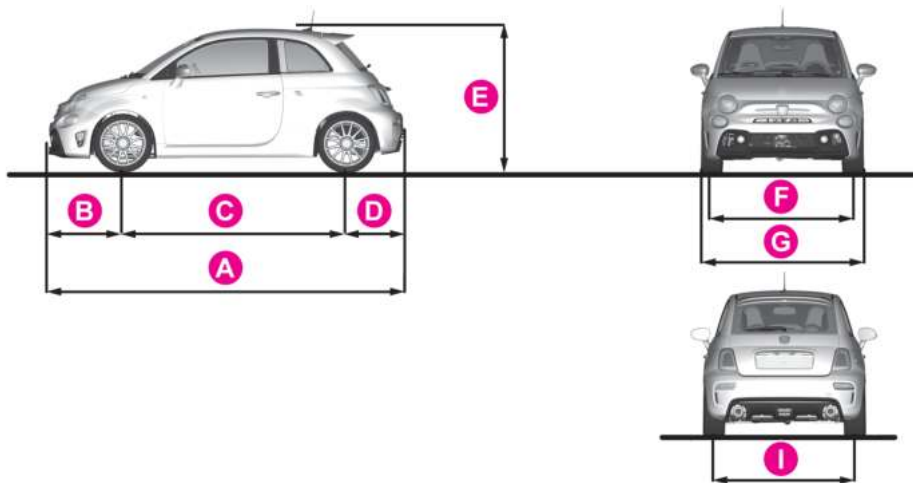

144

AB0A0292C

A	B	C	D	E	F	G	I
3660	770	2300	590	1490	1415/1409 (*)	1627	1408/1402 (*)

(\*) With 205/40 R17 tyres



## WEIGHTS AND LOADS

To identify the weights and masses of your car, refer to the car registration document containing the type-approved weights (for markets where provided) or the plate applied to the rear floor under the boot lining, next to the spare wheel compartment.

For versions/markets where provided, the plate may be on the driver's door pillar.



I45

FID1045

(D) Maximum authorised weight of fully laden car (GVW).

(E) Maximum authorised weight of fully laden car (GVW) plus trailer. If trailer towing is not permitted, values (D) and (E) are equal.

(F) Maximum permitted weight on front axle.

(G) Maximum permitted weight on rear axle.

WARNING A trailer cannot be towed so there are no provisions for fitting a tow hook.

## REFUELLING

Model	1.4 TB PETROL ABARTH	
	Prescribed fuels and original lubricants	
Fuel tank (litres)	35	Unleaded petrol no lower than 95 R.O.N. (EN228 specifications)
Fuel tank reserve (litres)	5	
Engine cooling system (litres)	5.15	50% mixture of distilled water and <b>PARAFLU UP</b> (*)
Engine sump (litres)	2.75	<b>SELENIA ABARTH 10W50</b>
Engine sump and filter (litres)	3.05	
Gearbox casing/differential (litres)	1.55	<b>TUTELA TRANSMISSION GEARFORCE</b>
Hydraulic brake circuit (kg)	0.55	<b>TOP 4/S</b>
Windscreen and rear window washer fluid reservoir (litres)	2.5	Mixture of water and <b>PETRONAS DURANCE SC35</b>

(\*) For particularly harsh climate conditions, a mixture of 60% PARAFLU UP and 40% distilled water is recommended.



## FLUIDS AND LUBRICANTS

Your car is equipped with an engine oil that has been thoroughly developed and tested in order to meet the requirements of the Service Schedule. Constant use of the prescribed lubricants guarantees the fuel consumption and emission specifications. Lubricant quality is crucial for engine operation and duration.

If lubricants conforming to the specific request are not available, products that meet the indicated specifications can be used to top up; in this case optimal performance of the engine is not guaranteed.



### PRODUCT SPECIFICATIONS

Use	Features	Specification	Original liquids and lubricants	Applications
Fully synthetic lubricant for ultra high performance engines	SAE 10W-50 ACEA C3	<b>9.55535-GH2</b>	<b>SELENIA ABARTH 10W50</b> Contractual Technical Reference No. 0101	According to Service Schedule
	Synthetic base lubricant SAE 75W grade	<b>9.55550-MZ6</b>	<b>TUTELA TRANSMISSION GEARFORCE</b> Contractual Technical Reference N° F002.F10	Manual gearbox and differential
Lubricants and greases for drive transmission	Fully synthetic lubricant with dedicated additive	<b>9.55550-SA1</b>	<b>TUTELA CS SPEED</b> Contractual Technical Reference N° F005.F98	Robotised sequential transmission hydraulic activation system
	Molybdenum disulphide grease, for use at high temperatures. N.L.G.I. consistency 1-2.	<b>9.55580-GRAS II</b>	<b>TUTELA ALL STAR</b> Contractual Technical Reference N° F702.G07	Wheel side constant velocity joints
	Low friction coefficient grease for constant velocity joints. N.L.G.I. consistency 0-1.	<b>9.55580-GRAS II</b>	<b>TUTELA STAR 700</b> Contractual Technical Reference N° F701.C07	Differential side constant velocity joints

Use	Features	Specification	Original liquids and lubricants	Applications
Brake fluid	Synthetic fluid for brake and clutch systems. Exceeds specifications F.M.V.S.S. no. 116 DOT 4, ISO 4925 SAE J1704.	<b>9.55597 or MS.90039</b>	<b>TUTELA TOP 4/S</b> Contractual Technical Reference N° F005.F15	Hydraulic brakes and hydraulic clutch controls
Protective agent for radiators	Red protective with antifreeze action, based on inhibited monoethyl glycol with organic formula. Exceeds CUNA NC 956-16, ASTM D 3306 specifications.	<b>9.55523 or MS.90032</b>	<b>PARAFLUUP</b> Contractual Technical Reference N° F101.M01	Cooling circuits proportions of use: 50% water 50% <b>PARAFLUUP</b> (*)
Windscreen/rear window washer fluid	Mixture of alcohol and surfactants Exceeds the CUNA NC 956-11 specifications.	<b>9.55522 or MS.90043</b>	<b>PETRONAS DURANCE SC35</b> Contractual Technical Reference N° F201.D02	To be used diluted or undiluted in windscreen washer/wiper systems

(\*) For particularly harsh climate conditions, a mixture of 60% PARAFLU UP and 40% distilled water is recommended.



### IMPORTANT

**55)** *The use of products with specifications other than those indicated above could cause damage to the engine not covered by the warranty.*



## PERFORMANCE

Model	Acceleration from 0–100 km/h (s)	Maximum speed (km/h)
1.4 TB PETROL ABARTH 135 HP (*)	7.9	205
1.4 TB PETROL ABARTH 145 HP	7.8 (**) / 8 (***)	210
1.4 TB PETROL ABARTH 160 HP	7.3 (**) / 7.4 (***)	216
1.4 TB PETROL ABARTH 163 HP (*) (****)	7.3 (**) / 7.4 (***)	218
1.4 TB PETROL ABARTH 165 HP (****)	7.3 (**) / 7.4 (***)	218
1.4 TB PETROL ABARTH 180 HP (****)	6.7 (**) / 6.9 (***)	225

(\*) For markets where provided

(\*\*) Version with manual transmission

(\*\*\*) Version with robotised sequential transmission

(\*\*\*\*) Values obtained using 98 RON unleaded petrol

## FUEL CONSUMPTION AND CO<sub>2</sub> EMISSIONS

The fuel consumption and CO<sub>2</sub> emission figures declared by the manufacturer are determined on the basis of the type-approval tests laid down by the applicable standards in the country where the car is registered.

The type of route, traffic conditions, weather conditions, driving style, general condition of the car, trim level/equipment/accessories, use of the climate control system, car load, presence of roof racks and other situations that adversely affect the aerodynamics or wind resistance lead to different fuel consumption values than those measured. The fuel consumption will only become more regular after driving the first 3000 km.

To find the specific fuel consumption and CO<sub>2</sub> emission figures for this car, please refer to the data in the Certificate of Conformity, and the related documentation that accompanies the car.



## **PRESCRIPTIONS FOR HANDLING THE CAR AT THE END OF ITS LIFE**

---

(for markets where provided)

FCA has been committed for many years to safeguarding the environment through the constant improvement of its production processes and manufacturing products that are increasingly "eco-compatible". To provide the best possible service in terms of compliance with environmental laws and European Directive 2000/53/EC governing cars at the end of their life, FCA is offering its customers the chance to hand over their car at the end of its life without incurring any additional costs. The European Directive specifies that when the car is handed over, the last keeper or owner should not incur any expenses as a result of it having a zero or negative market value.

To hand your car over at the end of its life without extra cost, contact one of our dealerships if you are purchasing another car, or a collection and scrapping centre authorised by FCA. These centres have been carefully chosen to offer a high quality service for the collection, treatment and recycling of cars at their end of life while respecting the environment.

You can find further information on these collection and scrapping centers either from an FCA dealership or by calling the number in the Warranty Booklet or by consulting the websites of the various FCA brands.

# MULTIMEDIA



*This chapter describes the main functions of the **Uconnect™** 5" LIVE, **Uconnect™** 5" Nav LIVE, **Uconnect™** 7" HD LIVE and **Uconnect™** 7" HD NAV LIVE infotainment systems that can be fitted on the vehicle.*

TIPS, CONTROLS AND GENERAL INFORMATION .....	168
AUX and USB SOURCE .....	169
Uconnect™ 5" LIVE / Nav LIVE ....	170
Uconnect™ 7" HD LIVE - Uconnect™ 7" HD NAV LIVE .....	182
MOPAR® CONNECT.....	196
OFFICIAL TYPE APPROVALS .....	198
RIGHT HAND DRIVE VERSION ....	199
INSTRUMENT PANEL FEATURES.....	200



## TIPS, CONTROLS AND GENERAL INFORMATION

### Road safety

Learn how to use the varied system functions before starting to drive. Read the instructions for the system carefully before starting to drive.

### Reception conditions

Reception conditions change constantly while driving. Reception may be interfered with by the presence of mountains, buildings or bridges, especially when you are far away from the broadcaster.

**WARNING** The volume may be increased when receiving traffic information and news.

### Care and maintenance

Observe the following precautions to ensure the system is fully operational:

- ▣ the display is sensitive to scratching, liquids and detergents. Avoid hitting the display with pointed or hard objects that could damage its surface. Do not press on the display when cleaning it.
- ▣ do not use alcohol, petrol and derived products to clean the display lens, and make sure that the

**Uconnect™** system is switched off during cleaning.

- ▣ prevent any liquid from entering the system: this could damage it beyond repair.

### Anti-theft protection

The system is equipped with an anti-theft protection system based on the exchange of information with the electronic control unit (Body Computer) in the car.

This guarantees maximum safety and prevents the secret code from being entered after the power supply has been disconnected. If the check has a positive outcome, the system will start to operate, whereas if the comparison codes are not the same or if the electronic control unit (Body Computer) is replaced, the system will ask the user to enter the secret code according to the procedure described in the paragraph below.

### Entering the secret code

When the system is switched on, if the code is requested, the display will show "Please enter Anti-Theft Code" followed by the screen showing a keypad to enter the secret code. The secret code is made up of four digits from 0 to 9. If an incorrect code is entered, the system displays "Incorrect Code" to notify the user of the need to enter

the correct code. After the 3 available attempts to enter the code, the system displays "Incorrect Code. Radio locked. Please wait for 30 minutes". After the text has disappeared it is possible to start the code entering procedure again.

### Car radio passport

This document certifies ownership of the system. The car radio passport shows the system model, serial number and secret code.

**WARNING** Keep the car radio passport in a safe place so that you can give the information to the relevant authorities if the system is stolen. In case you lose the radio passport, please go to an Abarth Dealership with an ID and the car papers.

### Important notes

In the event of an anomaly, the system should only be checked and repaired at an Abarth Dealership.

If the temperature is particularly low, the display may take a while to reach optimum brightness.

If the car is stopped for a while and the external temperature is very high, the system may go into "thermal protection" mode, suspending operation until the temperature in the

passenger compartment returns to acceptable levels.

Look at the screen only and when it is necessary and safe. If you need to look at the screen for a long time, pull over to a safe place so as not to be distracted while driving.

Immediately stop using the system in the event of a fault. Otherwise the system might be damaged. Contact an Abarth Dealership as soon as possible to have the system repaired.

## AUX and USB SOURCE

To connect an external device, use the AUX input fig. 146. To activate USB mode, insert a suitable device into the car USB port.

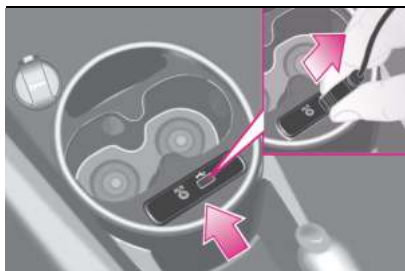

146

AB0A0427C

**WARNING** After using a USB recharging socket, we recommend disconnecting the device (smartphone),

always removing the cable from the vehicle socket first, never from the device fig. 146. Cables left flying or connected incorrectly could compromise correct recharging and/or the USB socket condition.







# Uconnect™ 5" LIVE / Nav LIVE

## Controls on front panel



## Front control panel summary table

Button	Functions	Mode
	Ignition	Short button press
	Switching off	Short button press
	Volume adjustment	Left/right rotation of knob
	Volume activation/deactivation (Mute/Pause)	Short button press
	Display on/off	Short button press
	Exit the selection/return to previous screen	Short button press
	Settings	Short button press
BROWSE ENTER	Scrolling the list or tuning to a radio station	Left/right rotation of knob
	Confirmation of the option displayed	Short button press
APPS	Access to the additional functions, e.g.: Time display, Compass (where provided), External temperature, Radio Media and <b>Uconnect™ LIVE</b> services, where present	Short button press
PHONE	Phone data display	Short button press
TRIP ( <b>Uconnect™ 5" LIVE</b> versions)	Access to the TRIP menu	Short button press
NAV ( <b>Uconnect™ 5" Nav LIVE</b> versions)	Access to the Navigation menu	Short button press
MEDIA	Source selection: USB, AUX, <b>Bluetooth®</b>	Short button press
RADIO	Access to the Radio mode	Short button press



## Controls on the steering wheel



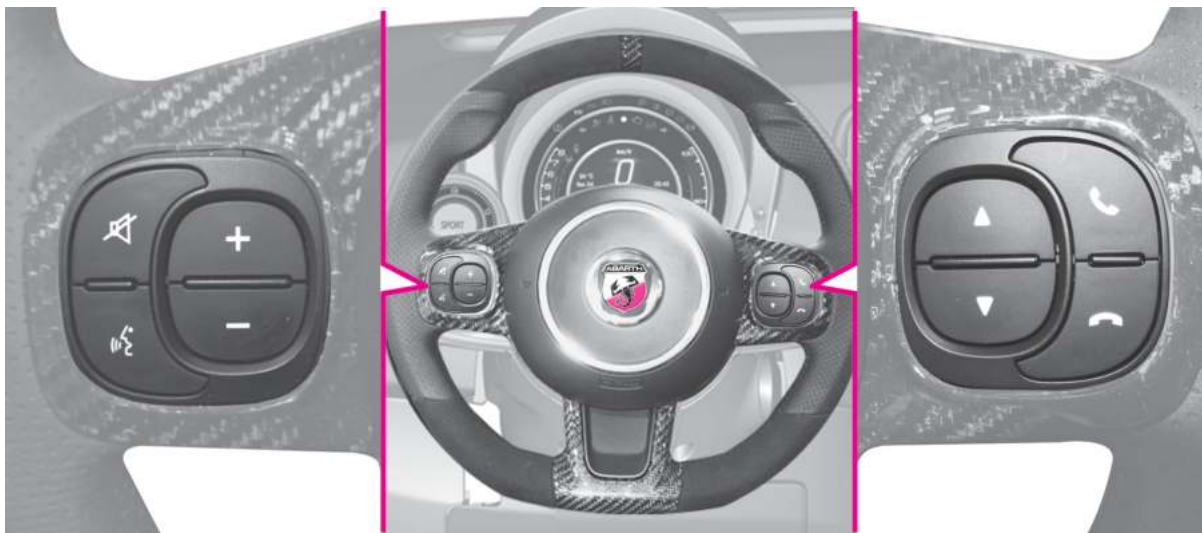

The controls for the main system functions are present on the steering wheel to make control easier. The activation of the function selected is controlled, in some cases, by how long the button is pressed (short or long press) as described in the table below.



148

AB0A0368C

## Controls on steering wheel summary table

Button	Interaction (pressure/rotation)
	<ul style="list-style-type: none"> <li>☐ Acceptance of incoming call;</li> <li>☐ Answering the second incoming call and putting the active call on hold;</li> <li>☐ Display of the last 10 calls on the instrument panel</li> </ul>
	<ul style="list-style-type: none"> <li>☐ Rejection of incoming call;</li> <li>☐ Ending of call in progress;</li> <li>☐ Exit the display on the instrument panel of the last calls (only with call browsing active)</li> </ul>
	<ul style="list-style-type: none"> <li>☐ Deactivation/reactivation of the microphone during a phone conversation;</li> <li>☐ Activation/deactivation of the USB, <b>Bluetooth®</b> source Pause;</li> <li>☐ Activation/deactivation of radio Mute function</li> </ul>
+/-	<ul style="list-style-type: none"> <li>☐ Short press: volume increase/decrease in single steps;</li> <li>☐ Long press: volume continuous increase/decrease until released</li> </ul>
	<ul style="list-style-type: none"> <li>☐ Activation of voice recognition;</li> <li>☐ Interruption of the voice message in order to give a new voice command;</li> <li>☐ Interruption of voice recognition</li> </ul>
	<p>Turning right wheel upwards or downwards:</p> <ul style="list-style-type: none"> <li>☐ Short press (Radio mode): selection of next/previous station</li> <li>☐ Long press (Radio mode): scan higher/lower frequencies until released</li> <li>☐ Short press (USB, <b>Bluetooth®</b> mode): selection of previous/next track</li> <li>☐ Long press (USB, <b>Bluetooth®</b> mode): fast forward/rewind until released</li> <li>☐ Short press (phone mode): selection of next/previous call (only with call browsing active)</li> </ul>



## Switching the system on/off

The system is switched on/off by pressing the  (ON/OFF) button/knob. Turn the button/knob clockwise to increase the radio volume or anticlockwise to decrease it.

## Radio mode

After the desired radio station is selected, the following information is shown on the display:

**At the top:** the list of radio stations stored (preset) is displayed; the station currently playing is highlighted.

**In the middle:** display of the name of the current radio station and the buttons for selecting the previous or next radio station.

**At the bottom:** display of the following buttons:

- ▮ "Browse": list of the radio stations available;
- ▮ "AM/FM", "AM/DAB", "FM/DAB": selection of the desired frequency band (button reconfigurable according to the band selected: AM, FM or DAB);
- ▮ "Tune": manual radio station tuning (not available for DAB radio);
- ▮ "Info": additional information on the source being listened to;
- ▮ "Audio": access to the "Audio Settings" screen.

**NOTE** The DAB frequency can be used in countries where digital transmission technology is available. The device will not be tuned to any frequency if the DAB button is pressed in a country where the service is not provided.

## Audio menu

The following adjustments can be carried out using the "Audio" menu:

- ▮ "Equalizer" (where provided);
- ▮ "Balance / Fader" (left/right and front/rear audio balance adjustment)
- ▮ "Volume / Speed" (speed-dependent automatic volume control);
- ▮ "Loudness" (where provided);
- ▮ "Auto-On Radio";
- ▮ "Radio Off Delay".





To exit the "Audio" menu, press the  / Done button.

## Media mode

### Audio source selection

Press the "Source" button to select the desired audio source among those available: AUX, USB or **Bluetooth®**. Applications used on portable devices may be not compatible with the **Uconnect™** system.

### Track selection (Browse)

With Media mode active, briefly press the  /  graphic buttons to play the previous/next track or keep the  /  buttons pressed to fast rewind/forward the track.

For languages not supported by the system which feature special characters (e.g. Greek), the keyboard is not available. In these cases this function will be limited.

## Bluetooth® source

### Pairing a Bluetooth® audio device

To pair a **Bluetooth®** audio device, proceed as follows:

- ▮ activate the Bluetooth® function on the device;
- ▮ press the MEDIA button on the front panel;
- ▮ if the "Media" source is active, press the "Source" graphic button;
- ▮ select the **Bluetooth®** Media source;
- ▮ press the "Add Device" graphic button;
- ▮ search for **Uconnect™** on the **Bluetooth®** audio device (during the pairing stage a screen is displayed showing the progress of the operation);
- ▮ when requested by the audio device, enter the PIN code shown on the system display or confirm on the device the PIN displayed;
- ▮ if the pairing procedure is completed successfully, a screen is displayed. Answer "Yes" to the question to pair the **Bluetooth®** audio device as favourite (the device will have priority over all other devices to be paired subsequently). If "No" is selected, the

priority is determined according to the order of connection. The last device connected will have the highest priority;  an audio device can also be paired by pressing the PHONE button on the front panel and by selecting "Settings" or, from the "Settings" menu, selecting "Phone/Bluetooth".





If the **Bluetooth®** connection between mobile phone and system is lost, consult the mobile phone handbook.

The Radio may change the track being played by modifying the name-device in the **Bluetooth®** settings of the telephone (where provided), if the device is connected via USB after the **Bluetooth®** connection.

## Phone mode

### Phone mode activation







Press the PHONE button on the front panel to activate the Phone mode. Use the graphic buttons on the display to:

-  dial the phone number (using the graphic dial pad on the display);
-  display and call the contacts in the phonebook of the mobile phone;
-  display and call contacts from the registers of previous calls;
-  pair up to 10 phones/audio device to make access and connection easier and quicker;
-  transfer calls from the system to the mobile phone and vice versa and deactivate the microphone

audio for private conversations. The mobile phone audio is transmitted through the car's sound system; the system automatically mutes the radio when the Phone function is used. To consult the list of mobile phones and supported functions, visit the [www.driveuconnect.eu](http://www.driveuconnect.eu) website

### Pairing a mobile phone

To pair the mobile phone, proceed as follows:

-  activate the **Bluetooth®** function on the mobile phone;
-  press the PHONE button on the front panel;
-  if no phone is paired with the system yet, the display shows a dedicated screen;
-  select "Yes" to start the pairing procedure, then search for the Uconnect™ device on the mobile phone (if "No" is selected, the Phone main screen is displayed);
-  when prompted by the mobile phone, use its keypad to enter the PIN code shown on the system display or confirm on the mobile phone the PIN displayed;
-  from the "Phone" screen you can always pair a mobile phone by pressing the "Settings" graphic button: press the "Add Device" graphic button and proceed as described above;

 during the pairing stage a screen appears on the display showing the progress of the operation;

 when the pairing procedure is completed successfully, a screen is displayed: answer "Yes" to the question to pair the mobile phone as favourite (the mobile phone will have priority over all other mobile phones to be paired subsequently). If no other devices are paired, the system will consider the first paired device as the favourite.





NOTE To ensure proper operation after updating the phone software, it is recommended to remove the phone from the list of devices linked to the radio, delete the previous system pairing also from the list of **Bluetooth®** devices on the phone and make a new pairing.

### Making a phone call

The operations described below can only be accessed if supported by the mobile phone in use.

For all functions available, refer to the mobile phone owner's handbook.

A call can be made by:

-  selecting the  icon (mobile phone phonebook);
-  selecting "Recent Calls";
-  selecting the  icon;



☐ pressing the "Redial" graphic button.

### Text Message Reader

The system can read the messages received by the mobile phone. To use this function, the mobile phone must support the text exchange function through **Bluetooth®**.

If this function is not supported by the phone, the corresponding graphic button  is deactivated (greyed out). When a text message is received, the display will show a screen where the options "Listen", "Call" or "Ignore" can be selected.

Press the  graphic button to access the list of text messages received by the mobile phone (the list displays a maximum of 60 messages received).

### Browsing text messages

(where provided)

Using the steering wheel commands, you can view and manage the last 10 SMS messages received on the instrument panel. To use this function, the mobile phone must support the text exchange function through **Bluetooth®**.

Select "Phone" on the instrument panel menu and then select "SMS reader" using the arrow keys on the steering wheel controls. The "Text message reader" submenu allows you to view and read the last 10 text messages.

**WARNING** Some mobile phones may not take the SMS delivery confirmation settings into account when interfacing with **Uconnect™**. If an SMS message is sent via **Uconnect™**, the user could face an additional cost, without any warning, due to the SMS delivery confirmation request sent by the phone. For any problems related to the above, contact your telephone service provider.

### Text message options

Default text messages are stored in the system memory and can be sent to answer a received message or as a new message:

- ☐ Yes.
- ☐ No.
- ☐ Okay.
- ☐ I can't talk right now.
- ☐ Call me.
- ☐ I'll call you later.
- ☐ I'm on my way.
- ☐ Thanks.
- ☐ I'll be late.
- ☐ Stuck in traffic.
- ☐ Start without me.
- ☐ Where are you?
- ☐ Are you there yet?
- ☐ I need directions.
- ☐ I'm lost.

☐ See you later.

☐ I will be 5 (or 10, 15, 20, 25, 30, 45, 60)\* minutes late.

☐ See you in 5 (or 10, 15, 20, 25, 30, 45, 60)\* minutes.

\* Only use the numbers listed, otherwise the system will not take the message.

NOTE See the dedicated section for details on how to send a text message using the voice commands.

### APPS Mode

Press the APPS button on the front panel to display the following operating settings:

- ☐ External temperature
- ☐ Clock
- ☐ Compass (NAV versions only)
- ☐ Trip (where present)
- ☐ **Uconnect™ LIVE**

### Uconnect™ LIVE Services

(where provided)

Press the APPS button to access a radio menu which shows all the application functions of the system, such as: Trip computer (where present), Settings, Compass (where present), **Uconnect™ LIVE** Applications.

If the **Uconnect™ LIVE** icon is there, the system is prepared for services linked to the use of applications for

more efficient and evolved use of the car, directly from the radio. The application functions are present according to the vehicle configuration and to the market.

To use the **Uconnect™ LIVE** services, you need to:

☐ Download the **Uconnect™ LIVE** App from the "Apple Store" or "Google play" on your compatible smartphone, making sure that the data connection is enabled.

☐ Use the **Uconnect™ LIVE** App to register on [www.driveuconnect.eu](http://www.driveuconnect.eu) or on the [www.fiat.it](http://www.fiat.it) website.

☐ Start the **Uconnect™ LIVE** App on the smartphone and enter your credentials.

For further information about the services available in your market, visit the [www.DriveUconnect.eu](http://www.DriveUconnect.eu) website.

### First access to the car

Once you have launched the **Uconnect™ LIVE** App and entered your details, you have to pair the **Bluetooth®** with your smartphone and the radio, as described in the "Pairing a mobile phone" paragraph, to access the **Uconnect™ LIVE** services in your vehicle.

The list of supported mobile phones is available on [www.driveuconnect.eu](http://www.driveuconnect.eu). When pairing is complete, the connected services can be accessed

by pressing the **Uconnect™ LIVE** icon on the radio. When the activation process is complete, a message will inform the user. If a personal profile is necessary for the services, your accounts can be connected through the **Uconnect™ LIVE** App, or in your personal area on [www.driveuconnect.eu](http://www.driveuconnect.eu).

### User not connected

If the user does not pair the phone with **Bluetooth®**, when the **Uconnect™ LIVE** button is pressed, the radio menu shows disabled icons, except for **eco:Drive™**.

Further information about the **eco:Drive™** functions is available in the dedicated chapter.

### Settings of the Uconnect™ services that can be managed through the radio

The "Settings" section can be accessed through the  icon in the radio menu dedicated to the **Uconnect™ LIVE** services. In this section the user can check the system options and change them according to their preferences.

### Systems updating

If an update for the **Uconnect™ LIVE** system is available while the **Uconnect™** services are being used,

you will be informed with a message on the radio screen.

The update includes a download of the new software version for managing the **Uconnect™ LIVE** services.

The update is made using the data connection of the paired smartphone. The amount of traffic generated will be communicated to the user.

### THE Uconnect™ LIVE APP

To access onboard services, you need to have installed the **Uconnect™ LIVE** App on your smartphone through which you can manage your profile and personalise your own **Uconnect™ LIVE** experience.

The App can be downloaded from "App Store" or "Google Play". For safety reasons, the App cannot be accessed when the phone is paired with the radio.

Access to **Uconnect™ LIVE** services via radio requires the entry of personal credentials (email and password), so the contents of your own personal account are protected and accessible only by the real user.

### Connected services that can be accessed on the car

The **Uconnect™ LIVE** services available in the radio menu can vary according to the market.



The my:Car app was developed to improve the customer's driving experience, therefore they are available in all markets where the **Uconnect™ LIVE** services can be accessed.

For further information visit the [www.driveuconnect.eu](http://www.driveuconnect.eu) website. If the navigation system is installed in the radio, accessing the **Uconnect™ LIVE** services enables use of the TomTom LIVE services. Further information about the LIVE functions is available in the dedicated chapter.

### eco:Drive™

The **eco:Drive™** application allows you to display your driving behaviour in real time, in order to help you reach a more efficient driving style as far as consumption and emissions are concerned.

It is also possible to consult the data on the **Uconnect™ LIVE** App.

Driving style is evaluated by means of four indices which monitor the following parameters:

- Acceleration
- Deceleration
- Shifting
- Speed

NOTE: It may not be possible to use the **eco:Drive™** data logging activation function and the data transfer via USB or Cloud, for versions

or markets, where provided even if present in the radio.

### eco:Drive™ display

Press the **eco:Drive™** graphic button to interact with the function.

A screen will be displayed on the radio, showing the 4 indices described above. These indices are grey until the system has enough data to evaluate the driving style. Once sufficient data are available, the indices will have 5 colours depending on the evaluation: dark green (very good), light green, yellow, orange and red (very bad).

It represents eco-friendliness of the driving style: from 0 (low) to 100 (high). In the event of extended inactivity the display will show the average of the indices up to that moment ("Average index") then the indices will be coloured again in real time as soon as the car is restarted.

To check the data average for the previous trip (the "trip" starts when the ignition key is turned to the MAR position and stops when it is turned to STOP), select the "Previous Route" button.

The details of the previous trip can also be displayed by pressing the "Details" button to show trip duration (time and mileage) and average speed.

### my:Car

my:Car allows you to keep the condition of your car always under control.

my:Car can detect malfunction in real time and inform the user about the expiry of the servicing interval. Press the "my:Car" button to interact with the application.

The display will show a screen with the "care:Index" section, which provides all the detailed information about the status of the vehicle. Press the "Active warnings" button (if present) to show the details of the faults of the car which caused a warning light to switch on.

The status of the car can be viewed on both the [www.driveuconnect.eu](http://www.driveuconnect.eu) and via the **Uconnect™ LIVE App**.

### Settings

Press the  button on the front panel to display the "Settings" main menu.

NOTE The menu items displayed vary according to the versions. The menu includes the following items:

- Display;
- Units;
- Voice Commands;
- Clock & Date;
- Lights (where provided);
- Doors & Locks;
- Vehicle Off Options;

- ☐ Audio;
- ☐ Phone / **Bluetooth®**;
- ☐ SiriusXM Setup (where provided);
- ☐ Radio Setup;
- ☐ Restore Settings;
- ☐ Clear Personal Data.

## Navigation (Uconnect™ 5" Nav LIVE only)

### Planning a route

**WARNING** In the interest of safety and to reduce distractions while you are driving, you should always plan a route before you start driving.

To plan a route, do the following:

- ☐ tap the screen to open the Main menu;
- ☐ tap "Navigate to";
- ☐ tap "Address". You can change the country or state setting by tapping the flag before you select a city;
- ☐ enter the town or city name, or the postcode. Towns with similar names are shown in the list while you type;
- ☐ enter the street name. Streets with similar names are shown in the list while you type. When the correct street name appears in the list, tap the name to select the destination;
- ☐ enter the house number, then tap "Done";
- ☐ if in the Advanced settings menu the "Show location preview" option is active, your position is shown on the

map. Tap "Select" to continue or tap "Back" to enter another address;

☐ when the new route is shown, tap "Done". For more information about the route, tap on "Details". To change your route, for example, to travel via a particular location or to select a new destination, tap "Change route". You are guided to your destination, using spoken instructions and on-screen directions.

### Updating the map

Two modes for downloading a map update are available:

- ☐ Most recent maps guarantee: if a new map is available for your system within 90 days of initial use, you can download it once free of charge.
- ☐ Map update: you can purchase a new version of the map installed on your system.

### Preparing a USB device

To update the map, use a USB device that meets the following requirements.

- ☐ The USB device should preferably be empty.
- ☐ The USB device must have at least 8 GB of free memory.
- ☐ The USB device must have a FAT-32 file system.
- ☐ The USB device must not be blocked and must allow files to be saved.

**NOTE:** the use of a memory stick is recommended, while the use of mass storage devices, such as mobile phones or multimedia players, is not recommended.

To prepare a USB device, proceed as follows:

- ☐ Select "Navigation updates" in the "Settings" menu. You are asked whether you wish to prepare a USB device for downloading updates.
- ☐ Select Yes.
- ☐ Insert the USB device.

**NOTE** If the system continues to ask you to insert the USB device, check that the device meets the requirements indicated previously, then retry.

The system starts to prepare the USB device.

When the USB device is ready, the following message is displayed.

Remove the USB device and connect it to the computer. The new map can now be downloaded to the USB device.

### TomTom HOME installation

To install TomTom HOME and create a MyTomTom account, proceed as follows:

- ☐ Download and install the TomTom HOME application on the computer. On the computer, access [tomtom.com/getstarted](http://tomtom.com/getstarted). Select



"Download TomTom HOME", then follow the instructions provided.

☞ Connect the USB device prepared with the computer. TomTom HOME is started automatically.

☞ Select "Log in" in the top right corner of TomTom HOME.

☞ Select "Create account" and enter the required details to create a MyTomTom account. A MyTomTom account is required to receive map updates. After the account is created, you are asked whether you wish to connect the **Uconnect™** system to your account. The USB device prepared represents your **Uconnect™** system.

☞ Select "Connect device", then select "close". A map can now be downloaded to the USB device.

### Downloading a map

The map can be updated in two ways:

☞ Most recent maps guarantee: if a new map is available for your system within 90 days of initial use, it can be downloaded once free of charge.

☞ Map update: it is possible to purchase a new version of the map installed on the system.

To check availability or purchase a map, make sure that you have prepared a USB device and installed TomTom HOME on your computer.

Connect the USB device to the computer.

### Downloading a map

If a map update is available for the system, this update is included in the list of updates available.

NOTE If the most recent map is already installed on the system, the update is not proposed. Select the map that you wish to download, then select "Update and install".

The map is downloaded and copied to your USB device.

Select "Done" when the process is complete.

NOTE Don't disconnect the USB device from the computer while map downloading and copying is in progress.

The map can now be installed on the system.

### Installing the map

After downloading a map to your USB device, it can be installed on your system.

WARNING The map update MUST be made with the vehicle engine running and may require more than 30 minutes.

WARNING Do not disconnect the USB device during the map installation

process, otherwise installation will be interrupted.

☞ Insert the USB device containing the new map in the **Uconnect™** system. The system detects a new map on the USB device.

☞ Select "Start".

Keep the device inserted. Before updating the map, the system indicates that this process may take several minutes. Select "OK".

NOTE Do not remove the USB device and do not disconnect the system's power supply before the update is complete. The system cannot be used until the update is completed correctly. If the update is interrupted, the system update is started again.

Once the map has been updated, the following message is displayed.

☞ Click on "Close".

The new map is now available on the system.

### Troubleshooting

The following problems may occur during the update:

☞ The map on the USB device is not valid. In this case, download the map to the USB device again, using TomTom HOME. It may be necessary to prepare the USB device again.

☞ The version of the map on the USB device is the same as or is a previous version of the one already on the system. In this case, download the map to the USB device again, using TomTom HOME. It may be necessary to prepare the USB device again.

## Voice Commands

NOTE For languages not supported by the system, voice commands are not available. To use the voice commands, press the button on the steering wheel  ("Voice" button) and say out loud the command you want to activate.

### Global

The following voice commands can be given after pressing the button on the steering wheel :

- ☞ Help
- ☞ Cancel
- ☞ Repeat
- ☞ Voice tutorial

### Phone

The following voice commands can be given after pressing the  button on the steering wheel and saying "Go to telephone":

- ☞ Call
- ☞ Dial
- ☞ Redial
- ☞ Call back

- ☞ Show recent calls
- ☞ Show outgoing calls
- ☞ Show missed calls
- ☞ Show incoming calls
- ☞ Phonebook
- ☞ Search
- ☞ Show text message

### Radio

The following voice commands can be given after pressing the button on the steering wheel :

- ☞ Tune to XXX FM
- ☞ Tune to XXX AM
- ☞ Tune in Radio XXX
- ☞ Tune in channel DAB

### Media

The following voice commands can be given after pressing the button on the steering wheel :

- ☞ Play song...
- ☞ Play album...
- ☞ Play artist...
- ☞ Play genre...
- ☞ Play playlist...
- ☞ Play podcast...
- ☞ Play audiobook...
- ☞ Select the source
- ☞ View

## Navigation (Uconnect™ 5" Nav LIVE only)

The following voice commands can be given after pressing the button on the steering wheel :

- ☞ Navigate home
- ☞ 2D vision
- ☞ 3D vision
- ☞ Clear route
- ☞ Add Favourite
- ☞ Repeat instruction

NOTE Voice entry of addresses is only supported in the country in which you are located and provided that the system language matches the local language. For example, if the car is located in Italy, it will be possible to enter Italian addresses only if the system language is set to "Italian".



# UCONNECT™ 7" HD LIVE - UCONNECT™ 7" HD NAV LIVE





## Controls on front panel



149

AB0A0399C

## Front control panel summary table

Button	Functions	Mode
	Ignition	Short button press
	Switching off	Short button press
	Volume adjustment	Left/right rotation of knob
	Volume activation/deactivation (Mute/Pause)	Short button press
	Display on/off	Short button press
	Exit the selection/return to previous screen	Short button press
<b>SCROLL TUNE</b> 	Scrolling the list or tuning to a radio station Media source track change	Left/right rotation of knob
	Confirmation of the option displayed in Radio mode, shows station list; in Media mode, allows to scroll source contents	Short button press



## Summary table of display buttons

Button	Functions	Mode
Radio	Access to the Radio mode	Press button
Media	Source selection: USB, AUX, <b>Bluetooth®</b>	Press button
Phone	Phone data display	Press button
<b>Uconnect™</b>	Access the additional functions (e.g. Compass display, <b>Uconnect™ LIVE</b> services)	Press button
Nav (*)	Access to the navigation function	Press button
Settings	Access the settings menu	Press button
Trip	Access to the Trip menu	Press button

(\*) **Uconnect™** 7" HD Nav LIVE versions only

## Controls on the steering wheel

The controls for the main system functions are present on the steering wheel to make control easier. The activation of the function selected is controlled, in some cases, by how long the button is pressed (short or long press) as described in the table below.







150

AB0A0368C



## Controls on steering wheel summary table

Buttons	Interaction
	<ul style="list-style-type: none"> <li>☞ Acceptance of incoming call</li> <li>☞ Answering the second incoming call and putting the active call on hold</li> <li>☞ Display of the last 10 calls on the instrument panel</li> </ul>
	<ul style="list-style-type: none"> <li>☞ Activation of voice recognition</li> <li>☞ Interruption of the voice message in order to give a new voice command</li> <li>☞ Interruption of voice recognition</li> </ul>
	<ul style="list-style-type: none"> <li>☞ Rejection of incoming call</li> <li>☞ Ending of call in progress</li> <li>☞ Exit the display on the instrument panel of the last calls (only with call browsing active)</li> </ul>
	<ul style="list-style-type: none"> <li>☞ Short press (Radio mode): selection of next/previous station</li> <li>☞ Long press (Radio mode): scan higher/lower frequencies until released</li> <li>☞ Short press (USB, <b>Bluetooth®</b> mode): selection of previous/next track</li> <li>☞ Long press (USB, <b>Bluetooth®</b> mode): fast forward/rewind until released</li> <li>☞ Short press (phone mode): selection of next/previous call (only with call browsing active)</li> </ul>
+/-	<ul style="list-style-type: none"> <li>☞ Short press: volume increase/decrease in single steps</li> <li>☞ Long press: volume continuous increase/decrease until released</li> </ul>

## Switching the system on/off

The system is switched on/off by pressing the button/knob .

Turn the button/knob clockwise to increase the radio volume or anticlockwise to decrease it. The electronic volume adjustment control rotates continuously (360°) in both directions, without stop positions.

## Radio mode

After the desired radio station is selected, the following information is shown on the display:

**At the top:** the list of radio stations stored (preset) is displayed; the station currently playing is highlighted.

**In the middle:** display of the name of the current radio station and the buttons for selecting the previous or next radio station.



**On the left:** display of the "AM", "FM", "DAB" buttons for selecting the desired frequency band (reconfigurable button depending on the selected band: AM, FM or DAB);

### On the right:

the following buttons:

- ☐ "Info": additional information on the source being listened to;
- ☐ "Map": navigation map view (versions with **Uconnect™ 7" HD Nav LIVE** only).

**At the bottom:** display of the following buttons:

- ☐ "Browse": list of the radio stations available;
- ☐  : selecting previous/next radio station;
- ☐ "Tune": manual radio station tuning;
- ☐ "Audio": access to the "Audio Settings" screen.

NOTE The DAB frequency can be used in countries where digital transmission technology is available. The device will not be tuned to any frequency if the DAB button is pressed in a country where the service is not provided.

## Audio menu

To access the "Audio" menu press the "Audio" button located at the bottom of the display.

The following adjustments can be carried out using the "Audio" menu:

- ☐ "Balance & Fader" (left/right and front/rear audio balance adjustment);
- ☐ "Equalizer" (where provided);
- ☐ "Speed Adj Volume" (speed-dependent automatic volume control);
- ☐ "Loudness" (where provided);
- ☐ "AUX volume compensation" (off in radio mode, selectable only with AUX source active);
- ☐ "AutoPlay";
- ☐ "Auto-On Radio".

## Media mode

Press the "Media" button to select the desired audio source among those available: USB, **Bluetooth®**, AUX.

WARNING Applications used on portable devices may be not compatible with the **Uconnect™** system.

After Media mode is selected, the following information is shown on the display:

**At the top:** information on the track being played and the following graphic buttons:

- ☐ "Repeat": to repeat the track being played;
- ☐ "Shuffle": to play the tracks in random order.

**In the middle:** information on the track being played.

**On the left:** display of the following buttons:

- ☐ Selected device or audio source;
- ☐ "Select source": select the required audio source.

**On the right:** display of the following buttons:

- ☐ "Info": additional information on the track being played;



- ☐ "Tracks": list of available tracks.
- ☐ "Map": navigation map view (versions with **Uconnect™ 7" HD Nav LIVE** only).

**At the bottom:** information on the track being played and the following graphic buttons:

- ☐ Active device or audio source;
- ☐ ◀▶ previous/next track selection;
- ☐ ||: pause track being played;
- ☐ "Audio": access to the "Audio Settings" screen.

### Track selection

Use this function to scroll through and select the tracks on the active device.

The choices available depend on the device connected. For example, on a USB device, you can also use the SCROLL TUNE button/knob to scroll through the list of artists, genres and albums available on the device, depending on the information available in the tracks.

NOTE This button might be disabled for some **Apple®** devices.

Press the "Tracks" graphic button to activate this function on the source being played.

Turn the SCROLL TUNE button/knob to select the desired category and then press the button/knob to confirm the selection.

NOTE The "Tracks" button does not allow any operation on the AUX device.  
NOTE The indexing time of a USB device can vary according to the media inserted (in some cases it can take a few minutes).

### Track search (Search)

This functions allows a dynamic search within a list of tracks.

### Bluetooth® SOURCE

This mode is activated by pairing a **Bluetooth®** device containing music tracks with the system.

### PAIRING A Bluetooth® AUDIO DEVICE

To pair a **Bluetooth®** audio device, proceed as follows:

- ☐ activate the **Bluetooth®** function on the device;
- ☐ press the "Media" graphic button on the display;
- ☐ press the "Select Source" button;
- ☐ select the **Bluetooth®** Media source;
- ☐ press the "Add Device" graphic button;
- ☐ search for "Uconnect" on the **Bluetooth®** audio device (during pairing, a screen showing the progress is displayed);
- ☐ when requested by the audio device, enter the PIN code shown on the

system display or confirm on the device the PIN displayed;

☐ if the pairing procedure is completed successfully, a screen is displayed. Answer "Yes" to the question to pair the **Bluetooth®** audio device as favourite (the device will have priority over all other devices to be paired subsequently). If "No" is selected, the priority is determined according to the order of connection. The last device connected will have the highest priority;

☐ an audio device can also be paired by pressing the "Phone" graphic button on the display and by selecting "Settings" or selecting "Phone/Bluetooth®" from the "Settings" menu.

WARNING If the **Bluetooth®** connection between mobile phone and system is lost, consult the mobile phone handbook.

NOTE When modifying the name-device in the **Bluetooth®** settings of the phone (where provided), the Radio may change the track being played if the device is connected via USB after the **Bluetooth®** connection.

After updating the phone software, for proper operation, it is recommended to remove the phone from the list of devices linked to the radio, delete the

previous system pairing also from the list of **Bluetooth®** devices on the phone and make a new pairing.

## USB SOURCE

To activate the USB mode, insert the corresponding device into the USB port on the central console.

If a USB device is inserted with the system on, it will start playing the tracks found on the device.

## AUX SOURCE

To activate AUX mode, insert an appropriate device in the AUX socket on the car.

When a device is inserted using the AUX output socket the system starts reproducing the AUX source connected, if it is already playing.

Adjust the volume using the  button/knob on the front panel or using the volume adjustment control on the connected device.

The "AUX volume compensation" function can be selected in Radio mode only when the AUX source is active.

**WARNING** The functions of the device connected with the AUX socket are directly managed by the device itself: it is not possible to change track/folder/playlist or control playing start/end/pause with the controls on

the front panel or on the steering wheel.

Do not leave the cable of your portable player connected to the AUX socket after disconnection, to avoid possible hiss from the speakers.

## TRIP COMPUTER

Press the "Trip" button on the display to view the car's trip information.

This function is composed of the "Instant info" items ("Range" and "Current fuel consumption") and the two separate trips called "Trip A" and "Trip B" for monitoring the vehicle's "complete journey" in a reciprocally independent manner.

Both functions can be reset (reset - start of a new journey): to reset the desired "Trip" hold down the "Trip A" or "Trip B" buttons.

## PHONE MODE





### PHONE MODE ACTIVATION

Press the "Phone" button on the display to activate the Phone mode.

**NOTE** To consult the list of mobile phones and supported functions, visit the [www.driveconnect.eu](http://www.driveconnect.eu) website.

Use the graphic buttons on the display to:

 dial the phone number (using the graphic dial pad on the display);

 display and call the contacts in the phonebook of the mobile phone;  
 display and call contacts from the registers of previous calls;  
 pair up to 10 phones/audio device to make access and connection easier and quicker;  
 transfer calls from the system to the mobile phone and vice versa and deactivate the microphone audio for private conversations.

The mobile phone audio is transmitted through the car's sound system; the system automatically mutes the radio when the Phone function is used.

## PAIRING A MOBILE PHONE

**WARNING** Carry out this operation only with car stationary and in safety conditions; this function is deactivated when the car is moving. The pairing procedure for a mobile phone is described below: always consult the handbook for the mobile phone in any case.

To pair the mobile phone, proceed as follows:

 activate the **Bluetooth®** function on the mobile phone;  
 press the "Phone" graphic button on the display;



- ☐ if no phone is paired with the system yet, the display shows a dedicated screen;
- ☐ access "Settings" and type "Add Device" to start the pairing procedure, then search for the **Uconnect™** device on the mobile phone;
- ☐ when prompted by the mobile phone, use its keypad to enter the PIN code shown on the system display or confirm on the mobile phone the PIN displayed;
- ☐ during the pairing stage a screen appears on the display showing the progress of the operation;
- ☐ when the pairing procedure is completed successfully, a screen is displayed: answer "Yes" to the question to pair the mobile phone as favourite (the mobile phone will have priority over all other mobile phones to be paired subsequently). If no other devices are paired, the system will consider the first paired device as the favourite.

NOTE To ensure proper operation after updating the phone software, it is recommended to remove the phone from the list of devices linked to the radio, delete the previous system pairing also from the list of **Bluetooth®** devices on the phone and make a new pairing.

## MAKING A PHONE CALL

The operations described below can only be accessed if supported by the mobile phone in use. For all functions available, refer to the mobile phone owner's handbook.

A call can be made by:

- ☐ selecting "Phonebook";
- ☐ selecting "Recent";
- ☐ selecting "Dial";

## FAVOURITES

You can add a number or a contact (if already in Contacts) to the favourite list during a call by pressing one of the five "Empty" graphic buttons on the upper part of the display. The favourites can also be managed by using the Phone Book options.

## TEXT MESSAGE READER

The system can read the messages received by the mobile phone. To use this function, the mobile phone must support the text exchange function through **Bluetooth®**.

If this operation is not supported by the phone, the corresponding "Text message" graphic button is deactivated (greyed out). When a text message is received, the display will show a screen where the options "Read", "Show", "Call" or "Ignore" can be selected. Press the "Text" graphic button to access the list of text messages

received by the mobile phone (the list displays a maximum of 60 messages received).

## TEXT MESSAGE OPTIONS

Predefined messages are stored in the system memory and can be sent to answer a received message or as a new message.

- ☐ Yes.
  - ☐ No.
  - ☐ Okay.
  - ☐ I can't talk right now.
  - ☐ Call me.
  - ☐ I'll call you later.
  - ☐ I'm on my way.
  - ☐ Thanks.
  - ☐ I'll be late.
  - ☐ Stuck in traffic.
  - ☐ Start without me.
  - ☐ Where are you?
  - ☐ Are you there yet?
  - ☐ I need directions.
  - ☐ I'm lost.
  - ☐ See you later.
  - ☐ I will be delayed by 5 (or 10, 15, 20, 25, 30, 45, 60) minutes (\*).
  - ☐ See you in 5 (or 10, 15, 20, 25, 30, 45, 60) minutes (\*).
- (\* Only use the numbers listed, otherwise the system will not take the message.

## DO NOT DISTURB FUNCTION

By pressing the "Do not disturb" graphic button the user will not receive notifications in case of incoming calls or text messages. The user can reply with a default or customised message by means of the settings.

## SIRI EYES FREE

(available only with iPhone 4S and subsequent versions and compatible iOS versions)

After having paired the Siri enabled device to **Uconnect™**, hold the  button on the steering wheel pressed and then release it.

After the double beep, you can start interacting with Siri, to listen to music, get directions, read text messages and more.

## APPS MODE

Press the "Uconnect" button on the display to access the radio menu containing all the system application operations.

The menu includes the following items:

- ☐ "Uconnect™ LIVE";
- ☐ "Media";
- ☐ "Phone";
- ☐ "Settings";
- ☐ "Radio";
- ☐ "Trip".

## Uconnect™ LIVE SERVICES

(where provided)

Press the **Uconnect™** button to access the **Uconnect™ LIVE** applications.

The services available depend on the car configuration and the market.

To use the **Uconnect™ LIVE** services, you need to download the **Uconnect™ LIVE** app from Google Play or Apple Store and register using the app or on [www.DriveUconnect.eu](http://www.DriveUconnect.eu).

## First access to the car

Once you have launched the **Uconnect™ LIVE** App and entered your details, you have to pair the **Bluetooth®** with your smartphone and the radio, as described in the "Pairing a mobile phone" paragraph, to access the **Uconnect™ LIVE** services in your vehicle.

When pairing is complete, the connected services can be accessed by pressing the **Uconnect™ LIVE** icon on the radio. Before using the connected services, you must complete the activation procedure following the instructions that appear in the **Uconnect™ LIVE** App once the **Bluetooth®** pairing has been completed.

## Uconnect™ LIVE services setup using the radio

The "Settings" section can be accessed through the  icon in the radio menu dedicated to the **Uconnect™ LIVE** services. In this section the user can check the system options and change them according to their preferences.

## System updates

If an update for the **Uconnect™ LIVE** system is available while the **Uconnect™ LIVE** services are being used, you will be informed with a message on the radio screen.



## Abarth Telemetry

The Abarth Telemetry application unlocks the potential of the new Abarth 595/695. The objective is to create driving confidence and make drivers more aware of their car's capabilities. Users will be able to measure their own performance thanks to a timer and new information available on the radio. Moreover, with Abarth Telemetry they will be able to receive driving advice in real time, record their itineraries and receive badges based on their behaviour at the wheel.

Abarth Telemetry will not only improve their driving experience, but will take it to a new level, allowing users to access

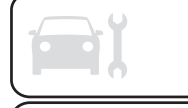

their performance on the smartphone thanks to the **Uconnect™ LIVE** App and, if they wish to give their consent, to share their performance with the **Uconnect™ LIVE** community on the [www.driveuconnect.eu](http://www.driveuconnect.eu) website.



151

AB0A0400

By pressing the **Uconnect™** keys, users will be able to access the following sections.

### **Badge**

The Badge section collects the users' successes. Each bronze, silver or gold badge may be locked/unlocked, depending on the performance of the user.

### **Timer**



152

AB0A0402

Displays trip times, average km times, distances etc.

### **Routes**

Users can select one of various itineraries, and to start the driving experience, view the itinerary map and access all the performances obtained. Moreover, after selecting the route, users can access their best performances and their sessions. Tips and useful information are available while driving.

### **My itineraries**

Users can create customised itineraries or select an itinerary from those that they have created previously. They can also record the GPS tracking from the starting point " A " to the destination " B ". After recording the A-B tracking, the GPS coordinates will be used to

create a customised itinerary that may be reused by the user in the future.

### **Settings**

Through the settings, users can select the measurement units and do a backup.

### **my:Car**



my:Car allows you to keep the condition of your car always under control.

my:Car can detect malfunction in real time and inform the user about the expiry of the servicing interval. Press the "my:Car" button to interact with the application.

The display will show a screen with the "care:Index" section, which provides all the detailed information about the status of the vehicle. Press the "Active warnings" button (if present) to show the details of the faults of the car which caused a warning light to switch on.

### **Apple CarPlay and Android Auto**

(for versions/markets, where provided)

The Apple CarPlay and Android Auto applications allow you to use your smartphone in the car safely and intuitively.

To enable them, just connect a compatible smartphone to the USB

port and the contents of the phone will be automatically shown on the **Uconnect™** system display.

To check the compatibility of your smartphone, see the indications on the websites: [https://www.android.com/intl/it\\_it/auto/](https://www.android.com/intl/it_it/auto/) and <http://www.apple.com/it/ios/carplay/>. If the smartphone is connected correctly to the car via the USB port, the Apple CarPlay or Android Auto icon will be displayed in place of the  button in the main menu.

### Android Auto – app configuration

Before use, download the Android Auto application to your smartphone from Google Play Store.

The application is compatible with Android 5.0 (Lollipop) and later versions.

To use Android Auto, the smartphone must be connected to the car with a USB cable. On the first connection, you will have to perform the setup procedure that appears on the smartphone. You can only perform this procedure with the vehicle stationary.

### Apple CarPlay – app configuration

Apple CarPlay is compatible with the iPhone 5 or more recent models, with the iOS 7.1 operating system or later versions.

Before using Apple CarPlay, enable Siri from Settings > General > Siri on the smartphone. To use Apple CarPlay, the smartphone must be connected to the car with a USB cable.

NOTE Enabling Apple CarPlay/Android Auto or some functions could require interaction on the smartphone. If necessary, complete the step on your device (smartphone).

### Interaction

After the setup procedure, the application will run automatically on the **Uconnect™** system when your smartphone is connected to the USB port in the car. You can interact with Apple CarPlay and Android Auto using the steering wheel controls (long press of the  button), using the SCROLL TUNE button/knob to select and confirm or using the **Uconnect™** system touchscreen.

### Navigation

With the Apple CarPlay and Android Auto applications, the user can choose to use the navigation system on their smartphone. If the system "Nav" mode is already on, a warning pop-up will appear on the **Uconnect™** system display when a device is connected to the car with a navigation session in progress. The pop-up allows the user to choose between using the

system navigation and using navigation controlled by the smartphone. The user can choose to change their selection at any time by accessing the navigation system that they want to use and setting a new destination.

### Setting "AutoShow smartphone display on connection"

Through the **Uconnect™** system settings, the user can decide to view the smartphone screen on the **Uconnect™** system display as soon as the smartphone is connected via the USB port. When this function is set, each time a connection is made via USB, the Apple CarPlay or Android Auto apps will run automatically on the radio app screen.

The "**AutoShow smartphone display on connection**" item can be found in the "Display" submenu.

The function is enabled by default.

NOTES

**Bluetooth®** is disabled while Apple CarPlay is being used

**Bluetooth®** remains on while Android Auto is being used

The data connection will depend on the tariff plan of the smartphone

This information may be subject to changes that depend on the smartphone's operating system.



## Exiting from the Apple CarPlay and Android Auto apps

You can still access the contents of the **Uconnect™** system with the CarPlay app enabled by using the controls available and viewable on its display. To return to the **Uconnect™** system contents with the Android Auto app enabled, select the last item on the Android Auto system bar and select "Back to Uconnect".

To end the Apple CarPlay or Android Auto session, physically disconnect the smartphone from the USB port.

## SETTINGS

Press the "Settings" button on the display to show the main "Settings" menu.

NOTE

The menu items displayed vary according to the versions. The menu includes the following items:

- ☐ Language;
- ☐ Display;
- ☐ Units;
- ☐ Voice Commands;
- ☐ Clock & Date;
- ☐ Safety & Driving Assistance (for versions/markets, where provided);
- ☐ Lights (for versions/markets, where provided);
- ☐ Doors & Locks;

- ☐ Engine Off Options;
- ☐ Audio;
- ☐ Phone;
- ☐ Radio Setup;
- ☐ Restore Default Settings;
- ☐ Clear Personal Data.

## NAVIGATION (Uconnect™ 7" HD Nav LIVE only)

Press the "Nav" button to show the navigation map on the display.

NOTE: The navigation system volume can only be adjusted during navigation when the system provides voice indications.

### Navigation main menu

In the navigation view, tap the "Main menu" button to open the menu:

- ☐ Select the "Search" button to search for an address, a place or a point of interest, then plan a route to the location.
- ☐ Select the "Current trip" button to delete or edit the planned route.
- ☐ Select the "My Places" button to create a collection of useful or preferred addresses. The following items are always available in "My Places": "Home" and "Recent Destinations".
- ☐ Select the "Parking" button to search for car parks.
- ☐ Select the "Weather" or "Report Speed Camera" button to receive

information on the weather or warnings about speed camera locations.

NOTE The "Weather" and "Report Speed Camera" functions are only active if TomTom Services are activated. Otherwise, the button will appear greyed out (and the function will not be available).

- ☐ Select the "Petrol Station" button to search for petrol stations.
- ☐ Select the "TomTom Services" button to view the activation state of the following services (subscription needed): "Traffic", "Speed Cameras", "Weather", "Online search".



Select this button to open the Settings Menu.



Select this button to open the "Help" menu. The Help Menu contains information about the **Uconnect™** system, for example, map version, device serial number and legal information.



Select this button to return to the navigation view.



Select this button to activate/deactivate voice instructions. Select off to no longer hear voice instructions. You will still receive information such as traffic information and warning sounds. **Tip:** you can deactivate the warning sounds by selecting "Settings", then "Sounds and warnings".



Select this button to increase/decrease the screen brightness and display the map in brighter/darker colours.

When driving at night or in unlit tunnels, watching the screen is more comfortable and less distracting for the driver if the map uses darker colours.

**Tip:** the device will automatically switch between day and night view depending on the time of day. To switch off this feature, select "Appearance" in the "Settings" menu and switch off "Switch to night colours when dark".

### Map update

To ensure optimal performance, the navigation system must be updated periodically. For this reason, the **Mopar® Map Care** service offers a new map update every three months.

The updates can be downloaded from the maps.mopar.eu website and installed directly on the navigator in your car. All updates are included for 3 years from the warranty start date, with

**Mopar® Map Care** active. **Mopar® Map Care** can be renewed at the end of the 3 year period. The navigation system can also be updated at the Abarth Dealership (the dealer may charge for updating the navigation system).

### VOICE COMMANDS

NOTE For languages not supported by the system, voice commands are not available.

To use the voice commands, press the button on the steering wheel  and say out loud the command you want to activate.

#### Global

The following voice commands can be given after pressing the button on the steering wheel  :

- Help
- Cancel
- Repeat
- Voice tutorial

### Phone

The following voice commands can be given after pressing the button on the steering wheel  :

- Call...
- Dial...
- Redial
- Call back
- Show recent calls
- Show outgoing calls
- Show missed calls
- Show incoming calls
- Phonebook
- Search...
- Show text message

TEXT MESSAGE voice commands:

- Send a text message to...
- Show messages

HANDS FREE CALLING voice commands:

- Send to number...
- Send...
- Hands free off
- Microphone on/off

### Radio

The following voice commands can be given after pressing the button on the steering wheel  :

- Tune to FM "frequency"
- Tune to AM "frequency"
- Tune to "radio name" FM
- Tune to "radio name" DAB channel



## Media

The following voice commands can be given after pressing the button on the steering wheel :

- ▮ Play song...
- ▮ Play album...
- ▮ Play artist...
- ▮ Play genre...
- ▮ Play playlist...
- ▮ Play podcast...
- ▮ Play audiobook...
- ▮ Select the source...
- ▮ View...

## Navigation (Uconnect™ 7" HD Nav LIVE only)

The following voice commands can be given after pressing the button on the steering wheel :

- ▮ Find "POI"
- ▮ Navigate to "address"
- ▮ Go to "city name" centre
- ▮ Navigate to an address
- ▮ Navigate to a city centre
- ▮ Navigate home
- ▮ Go via home
- ▮ Clear route
- ▮ Add current location to "My Places"
- ▮ View "My Places"
- ▮ Go through a saved location
- ▮ Recent Destinations
- ▮ Stop at a recent destination
- ▮ Increase zoom
- ▮ Zoom out

- ▮ 2D view
- ▮ 3D view
- ▮ Report Speed Camera
- ▮ Report Risk Zone

NOTE Voice entry of addresses is only supported in the country in which you are located and provided that the system language matches the local language. For example, if the car is located in Italy, it will be possible to enter Italian addresses only if the system language is set to "Italian".



### WARNING

**170)** *Do not carry out other operations during installation and wait for its completion, in order not to affect correct operation of the radio.*

**171)** *Where provided, the my:Car™ app is not intended to replace the Owner Handbook of the car.*

## MOPAR® CONNECT

(where provided)

These services let you keep your car under control at all times and receive assistance in the event of accident, theft or breakdown.

The presence of the services depends on the country (list available on the [www.driveuconnect.eu](http://www.driveuconnect.eu) website) and request activation by following the instructions received at the email address given when your car was handed over to you.

## SERVICES

According to the equipment of the car and of the country, different services may be available for different durations. For further information about your car, go to the personal page on the official Abarth website.

Some of the packages made available to the customer are:

▮ **my:Assistant:** package for customer assistance in case of accident, breakdown or attempted theft. The package can be accessed from the **Uconnect™ LIVE** app and can also be used to detect unauthorised towing or tampering of the car.

▮ **my:RemoteControl:** package for managing remote functions from the **Uconnect™ LIVE** smartphone app,

such of the car location on the map or locking/unlocking the doors, unlocking the boot and flashing the hazard warning lights for 4 seconds.

☞ **my:Car:** package for remote monitoring of the car status, such as fuel level and tyre pressure, using the **Uconnect™ LIVE** App. The package also includes the Vehicle Condition Report to check the state of health of the car via web and with a monthly email.

☞ **my:Journey:** package for viewing and managing your journeys using the **Uconnect™ LIVE** app with dates, maps, personal notes and travel reports.

☞ **My Fleet Manager** package for managing cars and light commercial vehicle fleets efficiently and securely. Download the **Uconnect™ LIVE** app for smartphones or access the [www.driveuconnect.eu](http://www.driveuconnect.eu) portal to use the connected services. You can find all the details about the services in the **Mopar® Connect** section of the [www.driveuconnect.eu](http://www.driveuconnect.eu) portal.

The main functions of the **My:RemoteControl** and **My:Car** packages (where provided) can be run using Google Assistant voice commands (where provided), in addition to the **Uconnect™ LIVE** app and the web portal

[www.driveuconnect.eu](http://www.driveuconnect.eu). With **Mobility Services**, it is also possible to take advantage of proposals from FCA partners.

### PRIVACY MODE

Privacy mode lets you disable the “Find car”, “Notify Area” and “Notify Speed” services, which allow registered customers to locate their cars, for a fixed time.

WARNING Car position tracing remains active for the assistance services, where provided, in the event of accident or car theft, but is not visible to the customer.

### PRIVACY MODE activation procedure

Proceed as follows:

- ☞ take note of the total odometer reading;
- ☞ make sure that the instrument panel is off;
- ☞ Send the following text message to +393424112613: "PRIVACY <VEHICLE\_CHASSIS\_NUM> <TOTAL\_MILEAGE\_KM>" (e.g.: PRIVACY ZFA3340000P12345612532). You can find the vehicle identification number in the registration document;

☞ before starting the engine, wait to receive the text message confirming that Privacy mode has been activated and indicating when it expires.

When you have received the confirmation, you can start your trip in the knowledge that the car will not be tracked until the indicated expiry time. If it expires while you are still travelling, Privacy mode will be extended until you turn off the engine (instrument panel off).

If you receive a text message indicating that your request was not successful, you must be aware that the car will continue to be visible to the registered customer.

If you have any problems during activation, consult the FAQ on the [www.driveuconnect.eu](http://www.driveuconnect.eu) portal, contact the Abarth Dealership or contact Customer Care.



## **OFFICIAL TYPE APPROVALS**

---

### **Radio devices**

All radio equipment provided with the car complies with Directive 2014/53/EU, UA.RED.TR, the French SAR Decree Law of 15/11/2019 and the UKCA (UK Conformity Assessed) Certification of 01/01/2021 in force in the United Kingdom. For further information visit the [www.mopar.eu/owner](http://www.mopar.eu/owner) or <http://aftersales.fiat.com/elum/> websites

### **Radio frequency devices**

All radio frequency devices comply with the regulations in force in the countries in which they are sold.

For further information go to [www.mopar.eu/owner](http://www.mopar.eu/owner) or <http://aftersales.fiat.com/elum>.

## RIGHT HAND DRIVE VERSION

### DASHBOARD

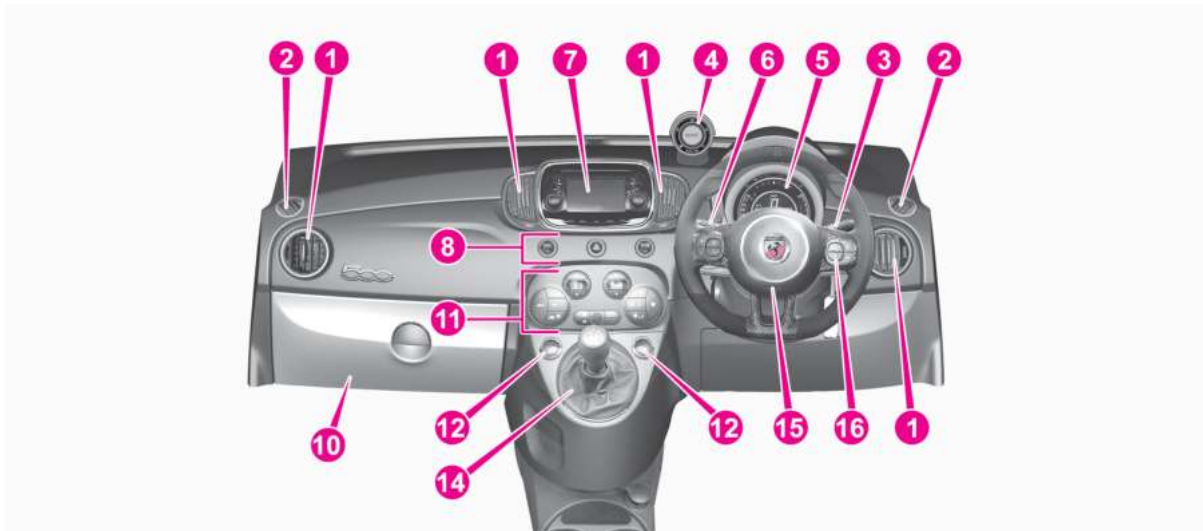

153

AB0A0391C

1. Adjustable air vents 2. Fixed air vents 3. Left stalk: direction indicators, dipped beam headlights, main beam headlights, Lane change function 4. Turbo pressure gauge, "SPORT" display 5. Instrument panel 6. Right stalk: windscreen washer/wiper, rear window washer/wiper 7. **Uconnect™** multimedia system 8. "SPORT" mode, emergency lights, front/rear fog lights 9. Passenger front airbag 10. Glove compartment 11. Climate control system controls 12. Electric windows 13. Glove compartment 14. Shifting 15. Front driver side airbag 16. **Uconnect™** system steering wheel controls



## INSTRUMENT PANEL FEATURES



154

AB0A0475

1. Odometer (display of distance travelled in kilometres/miles) 2. Digital engine coolant temperature gauge 3. Digital rev counter (tachometer) 4. Range 5. SBR system indications 6. Outside temperature gauge 7. Car speed indication 8. Schedule 9. Current Consumption 10. Digital fuel level gauge 11. Current consumption (numeric)

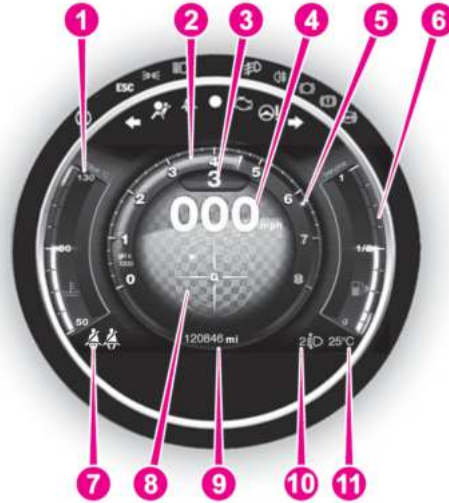

155

AB0A0476

1. Digital engine coolant temperature gauge
2. Digital rev counter (tachometer)
3. Engaged gear indicator
4. Car speed indication
5. Maximum engine rpm reached ("Ghost function")
6. Digital fuel level gauge
7. SBR system indications
8. Longitudinal/lateral instantaneous acceleration
9. Odometer (display of distance travelled in kilometres/miles)
10. Front headlight aiming
11. Outside temperature gauge





**SELENIA,  
PER CHI SI SENTE  
DAVERO ABARTH**

**SELENIA,  
REAL ABARTH  
PEOPLE**

**CHOOSING GENUINE PARTS  
IS THE MOST NATURAL CHOICE**



PERFORMANCE



GENUINE PARTS

COMFORT



GENUINE PARTS

SAFETY



GENUINE PARTS

AMBIENT



GENUINE PARTS

ACCESSORIES



GENUINE PARTS

VALUES



GENUINE PARTS

## HOW TO RECOGNISE GENUINE PARTS

To recognise a **Genuine Part**, check **that the component bears our brands**, always clearly visible on Genuine Parts, from the braking system to windscreen wipers, from shock absorbers to pollen filter.

All **Genuine Parts** undergo **strict controls**, both during design and manufacturing stages, by specialists using **vanguard materials**, to **test the component reliability**.

This to guarantee **performance** and **safety** for you and your passengers on board, for a long time.

Always ask for and make sure a **Genuine Part** has been used.



Pollen filter

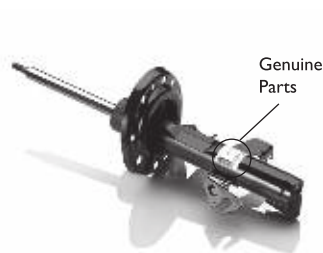

Shock absorber

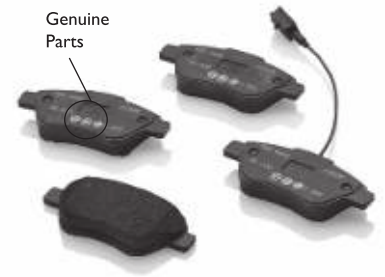

Brake pads

**MAINTAIN YOUR VEHICLE IN  
TIP TOP CONDITIONS WITH**



**Mopar Vehicle Protection** offers a series of service contracts that are designed to give all our customers the pleasure of driving their vehicle without any hitch's and concerns.

Our product portfolio consists of a wide and flexible range of **extended warranty and maintenance plans** endorsed by FCA. Each with a series of **different coverage tiers, in terms of durability and mileage**, built to accommodate you're driving needs.

Service contracts are made by experts that know every part of your vehicle, and commit themselves to **maintain it in tip top conditions**. Our knowledge and passion is tailored around designing products that promises all our drivers "worry-free driving".

Only with Mopar Vehicle Protection you are ensured that all service operations are performed by **highly qualified and specialized technicians in authorized FCA repair facilities, using the right tools, equipment and only original parts, all over Europe**.

Check which Service Contract plans are available on your market today and choose the Service Contract that suits your driving habits best.

Ask your local dealer for further information.







# CONTENTS

<b>A</b> nalogue pressure gauge . . . . .	43	plastic parts . . . . .	145	Dualdrive electric power steering . . . . .	99
Audio system . . . . .	41	seats . . . . .	145	<b>E</b> lectric windows . . . . .	30
Automatic climate control system . . . . .	28	Clutch . . . . .	151	Emergency starting . . . . .	122
AUX and USB ports . . . . .	38	CO2 emissions . . . . .	165	Engine . . . . .	148
<b>B</b> attery		Correct reading of the rim code . . . . .	155	Engine coolant . . . . .	134
inspecting the charge . . . . .	135	Correct reading of the tyre . . . . .	155	Engine oil (consumption) . . . . .	134
recharging . . . . .	136	Cup/bottle holders . . . . .	38	Engine oil (level check) . . . . .	134
replacement . . . . .	135	Current Consumption . . . . .	43	EOBD system . . . . .	53
tips for extending battery life . . . . .	135	<b>D</b> ashboard . . . . .	10	External lights . . . . .	20
Bodywork (cleaning and maintenance) . . . . .	141	Daytime running lights (DRL) . . . . .	20	<b>F</b> iat CODE system . . . . .	13
Bonnet . . . . .	36	Daytime running lights (DRL) . . . . .	20	Fire extinguisher . . . . .	40
Boot		Digital engine coolant temperature gauge . . . . .	43	Fix&Go kit . . . . .	120
closing . . . . .	37	Digital fuel level gauge . . . . .	43	Flashing the headlights . . . . .	20
extending the boot . . . . .	37	Dimensions . . . . .	159	Fluids and lubricants . . . . .	162
Boot ceiling light (bulb replacement) . . . . .	113	Dipped headlights (bulb replacement) . . . . .	110	Fog light/rear fog light . . . . .	20
Brake fluid . . . . .	134	Dipped headlights/side lights . . . . .	20	Fog lights (bulb replacement) . . . . .	110
Brakes . . . . .	152	Direction indicators . . . . .	20	Follow Me Home (device) . . . . .	20
<b>C</b> ar inactivity . . . . .	140	Direction indicators (bulb replacement) . . . . .	110	Front airbags . . . . .	86
Checking levels . . . . .	131	Doors		Front ceiling light . . . . .	22
Child restraint systems . . . . .	76	Door central locking/unlocking . . . . .	14	Front light clusters (bulb replacement) . . . . .	110
Cigarette lighter . . . . .	38	door locking/unlocking . . . . .	14	Fuel consumption . . . . .	165
Cleaning and maintenance		opening/closing with the key . . . . .	14	Fuel cut-off system . . . . .	123
interiors . . . . .	145	Driver knee bag . . . . .	86	Fuel tank cap . . . . .	103
leather parts . . . . .	145	Driver's side front airbag . . . . .	86	Fuse boxes (location) . . . . .	114
				Fuses (replacement) . . . . .	114
				<b>G</b> ear Shift Indicator (system) . . . . .	43



Glove compartment . . . . .	38	Light bulbs	
<b>H</b> andbrake . . . . .	95	bulb types . . . . .	107
Hazard warning lights . . . . .	107	bulbs (replacement) . . . . .	107
Head restraints . . . . .	18	general instructions . . . . .	107
rear head restraints . . . . .	18	Lubricants (specifications) . . . . .	162
Headlight alignment corrector . . . . .	20	<b>M</b> ain beam headlights . . . . .	20
Headlights (washing) . . . . .	141	Main beam headlights (bulb	
Heated rear window		replacement) . . . . .	110
(activation) . . . . .	26	Manual climate control system . . . . .	26
<b>I</b> dentification data		controls . . . . .	26
body paint identification		Menu items . . . . .	46
plate . . . . .	147	Mopar Connect . . . . .	196
chassis marking . . . . .	147	Motor	
engine marking . . . . .	147	marking . . . . .	147
VIN plate . . . . .	147	Motor compartment	
Ignition device . . . . .	13	(washing) . . . . .	141
Installing a child carseat with		<b>N</b> umber plate lights (bulb	
seatbelts . . . . .	76	replacement) . . . . .	110
Installing an ISOFIX child restraint		<b>O</b> ccupant protection systems . . . . .	72
system . . . . .	76	Official type approvals . . . . .	198
Instrument panel features . . . . .	43	<b>P</b> aintwork (maintenance) . . . . .	141
Intake system . . . . .	150	Parking sensors . . . . .	101
Interior ceiling light (bulb		Passenger front airbag . . . . .	86
replacement) . . . . .	113	Performance . . . . .	164
Interior fittings . . . . .	38	Power socket . . . . .	38
Interior lights . . . . .	22	Pre-tensioners . . . . .	74
Interiors (cleaning) . . . . .	145	load limiters . . . . .	74
iTPMS . . . . .	70	Protecting the environment . . . . .	41
<b>L</b> ifting the vehicle . . . . .	138		
		<b>R</b> ear light clusters (bulb	
		replacement) . . . . .	110
		Rear seats (backrest release) . . . . .	15
		Rear window washer (jets) . . . . .	137
		Rear window wiper/washer . . . . .	23
		Rear-view mirrors . . . . .	19
		Reconfigurable multifunction	
		display . . . . .	43
		Refuelling . . . . .	161
		Refuelling the car . . . . .	103
		Replacing an exterior bulb . . . . .	110
		Replacing interior bulbs . . . . .	113
		Rim Protector (tyres) . . . . .	155
		Rims	
		dimensions . . . . .	155
		wheels and tyres . . . . .	139
		Rims and wheels . . . . .	155
		Roof rack/ ski rack . . . . .	40
		<b>S</b> afety . . . . .	72
		seat belts . . . . .	72
		Safety systems . . . . .	67
		Saving fuel . . . . .	104
		SBR system . . . . .	73
		Seat belts	
		using the seat belts . . . . .	72
		Seat belts (maintenance) . . . . .	74
		Seats	
		front seats . . . . .	15

Sensors	mechanical key . . . . .	11	Uconnect™ 5"/7" HD	
parking . . . . .	Third brake light (bulb		AUX and USB source . . . . .	169
Service Schedule . . . . .	replacement) . . . . .	110	Tips, controls and	
Demanding use of the car . . . . .	Towing the car . . . . .	123	information . . . . .	168
Servicing and maintenance . . . . .	Transmission . . . . .	151	Uconnect™ 7" HD	
periodic checks . . . . .	TRIP button . . . . .	52	Android Auto . . . . .	187
scheduled servicing . . . . .	Trip computer . . . . .	52	Apple CarPlay . . . . .	187
Side bags - window bags . . . . .	Tyres		AUX source . . . . .	187
Side bags (front side airbags) . . . . .	inflation pressures . . . . .	155	Bluetooth® source . . . . .	187
Side lights/daytime running lights	snow tyres . . . . .	155	controls on front panel . . . . .	182
(bulb replacement) . . . . .	tyres fitted . . . . .	155	controls on the steering	
Snow chains . . . . .	Tyres - maintenance . . . . .	139	wheel . . . . .	182
Snow tyres . . . . .	<b>U</b> connect™ 5"		Media mode . . . . .	187
Soft top . . . . .	APPS mode . . . . .	174	navigation . . . . .	187
Spark plugs (type) . . . . .	Bluetooth® source . . . . .	174	phone mode . . . . .	187
Speedometer . . . . .	controls on front panel . . . . .	170	settings . . . . .	187
Sport front seats . . . . .	controls on the steering		switching the system	
SPORT function . . . . .	wheel . . . . .	170	on/off . . . . .	187
Starting the engine . . . . .	eco:Drive™ . . . . .	174	trip computer . . . . .	187
Steering . . . . .	Media mode . . . . .	174	Uconnect™ LIVE services . . . . .	187
Steering wheel . . . . .	my:Car . . . . .	174	USB source . . . . .	187
Storage compartment . . . . .	navigation . . . . .	174	voice commands . . . . .	187
Sun visors . . . . .	phone mode . . . . .	174	Using the manual transmission . . . . .	95
Sunroof . . . . .	settings . . . . .	174	Using the robotised sequential	
Suspension . . . . .	switching the system		transmission . . . . .	96
<b>T</b> achometer . . . . .	on/off . . . . .	174	<b>W</b> arning lights and messages . . . . .	55
Technical specifications . . . . .	Uconnect™ LIVE services . . . . .	174	Washing and cleaning the soft	
The keys	voice commands . . . . .	174	top . . . . .	141
key with remote control . . . . .			Weights and loads . . . . .	160

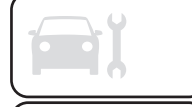

## CONTENTS

Wheels and tyres . . . . .	139
tyre inflation pressure . . . . .	155
When parked . . . . .	95
Window bags (side airbags for head protection) . . . . .	86
Window washing . . . . .	23
Windows (cleaning) . . . . .	141
Windscreen washer (jets) . . . . .	137
Windscreen wiper/ washer . . . . .	23
Windscreen/rear window washer fluid . . . . .	134
Windscreen/rear window wiper (blades) . . . . .	137